

Baús e Carrocerias

Edição Nº 19

Implementos Rodoviários



asa
alumínio

ALUTRUCKS

Nossa história, **nosso nome**, nossa identidade. **Asa sempre!**



www.asaaluminio.com.br





asa
alumínio

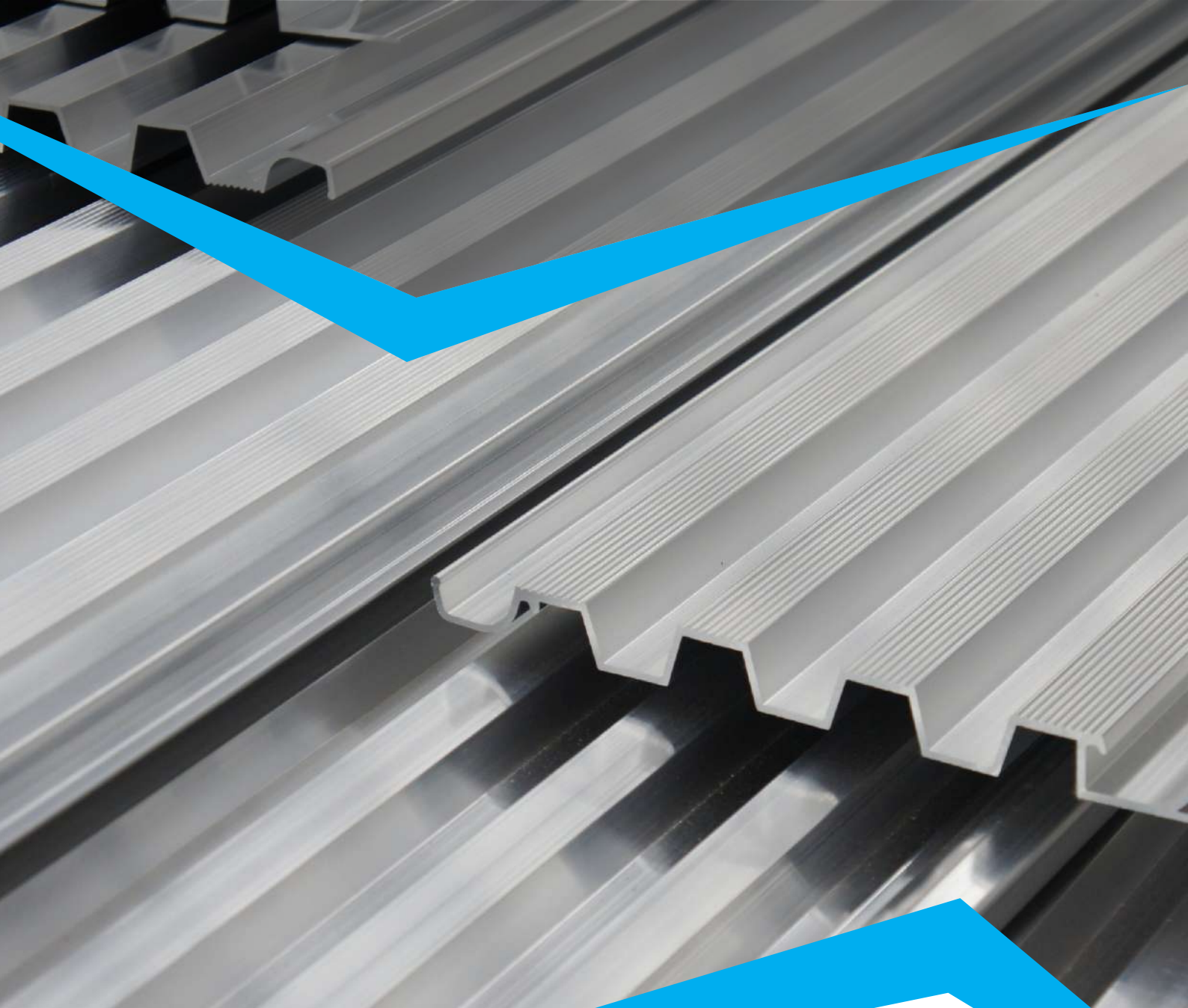

PERFIS PARA IMPLEMENTOS RODOVIÁRIOS ASAALUMÍNIO.

Com o intuito de disponibilizar uma ampla gama de soluções em perfis de alumínio, para uso em veículos da categoria pesada. Trabalhamos incessantemente e investindo em novos produtos para carrocerias de transporte diversos.

Com um amplo portfólio de perfis para fabricação de baús, carrocerias modulares, graneleiros, reboques, semirreboques, sider e carrocerias especiais.

Contamos com estrutura voltada para a excelência no atendimento e suporte técnico para desenvolvimento de perfis de grandes dimensões e rapidez na produção de ferramentas, á Asa Alumínio está pronta para lhe auxiliar nos desafios de soluções customizadas para cada demanda.

asa
alumínio

ÍNDICE

Cód. Perfil	kg/m	Pag.	Cód. Perfil	kg/m	Pag.	Cód. Perfil	kg/m	Pag.
19195	0,128	42	39102	2,560	46	39315	1,053	17
19196	0,120	42	39103	1,062	19	39316	1,942	10
19227	2,227	41	391127C	0,828	38	39324	2,867	36
19364	1,712	15	39113	1,484	31	39325	4,47	7
19660E	2,490	39	391181C	2,003	16	39339	1,046	20
19710E	2,086	40	391187C	1,314	12	39340	0,87	21
19725C	1,496	41	391198C	0,809	20	39362	0,924	31
19772E	1,729	34	391200D	2,073	15	39449	1,192	30
19792E	3,930	33	391227D	1,806	26	39577	0,886	21
19793E	4,027	33	391417C	1,730	45	39684	1,070	37
19807D	3,387	32	391421D	1,382	36	39685	0,797	21
19833E	2,476	35	391440C	0,525	19	39686	0,733	18
19879C	1,720	29	391441C	1,023	6	39687	0,627	19
23010	0,933	23	391486D	8,372	46	39688	2,028	27
23033C	0,792	23	391496D	2,222	7	40003	0,556	44
23034D	1,657	23	391497C	1,748	11	40005	0,852	21
29053	0,999	24	39154	2,432	31	40006	0,450	44
29057	3,183	26	391568D	2,635	10	40007	0,700	21
29068	0,747	18	391595C	1,510	31	40008	0,745	36
29069	2,265	28	391608D	1,354	14	40013	0,442	44
29071	1,045	36	391613C	0,538	24	54010	2,633	6
29112	1,138	12	391660C	0,564	17	65269D	0,792	19
29113	1,049	8	391661C	1,025	14	781095D	2,149	39
29125	0,714	18	391662D	1,412	27	781096C	0,325	39
29152	0,894	18	391664D	1,354	8	78122	1,074	30
29235C	0,961	24	391665D	1,361	9	781372E	6,672	47
29238D	1,357	25	39172	2,029	9	781386C	0,578	42
29239C	0,681	22	39173	1,681	21	781433E	6,497	48
29248D	1,479	25	39177	0,816	37	781445C	1,184	38
29274D	1,811	22	39178	0,777	17	781448C	0,490	42
29288E	2,189	33	391781D	2,025	13	781584E	6,287	47
29290C	1,031	14	391928C	1,465	13	781835C	1,619	38
31010	0,603	42	391929C	1,262	14	78215	2,262	16
31075C	1,019	45	391966C	0,559	31	TUB4046	1,127	38
31076C	1,189	45	392067C	3,151	11			
35005	0,643	45	39275	1,367	16			
35015C	0,401	24	39285	2,344	43			
39100	2,684	18	39313	0,913	20			
39101	2,032	43	39314	0,886	37			

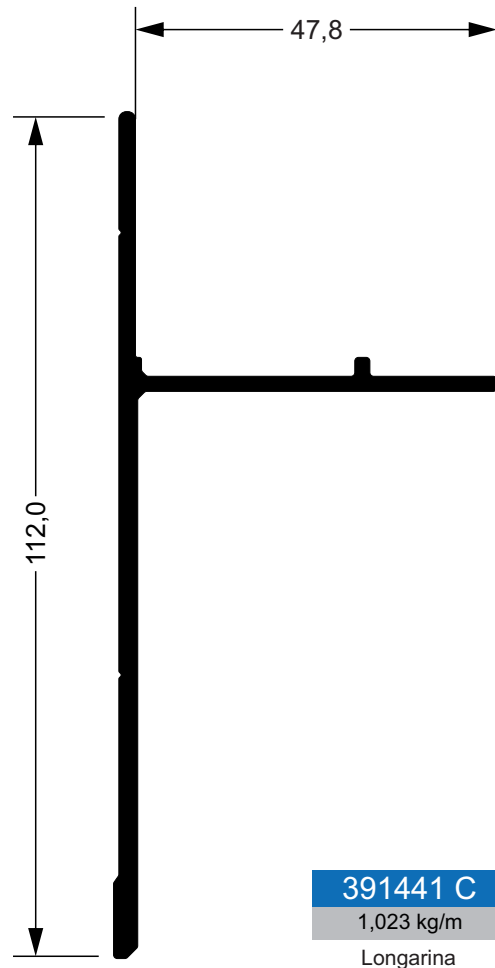
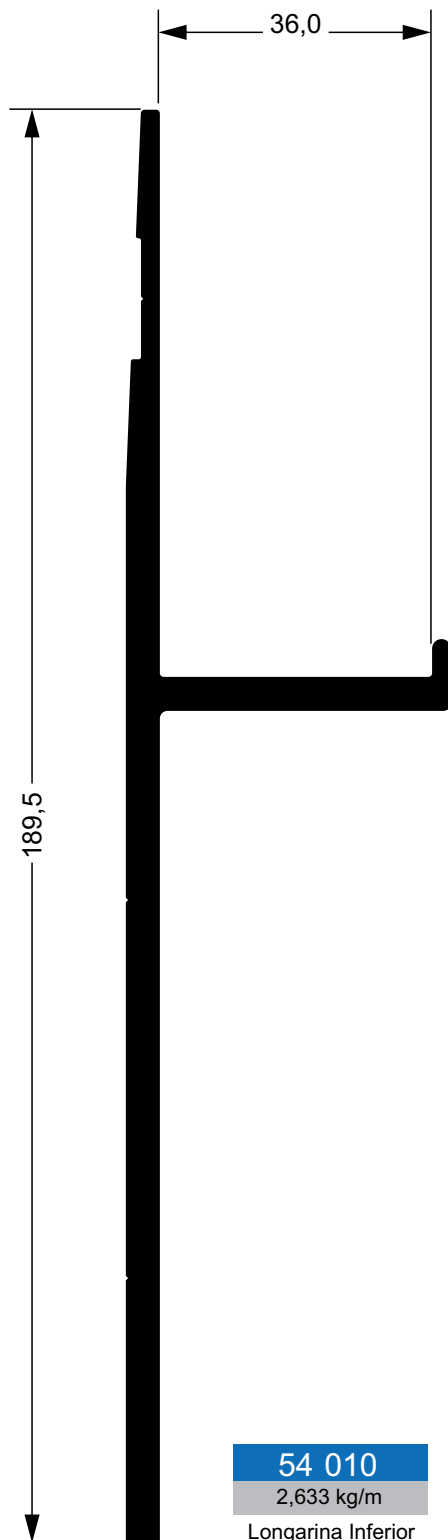

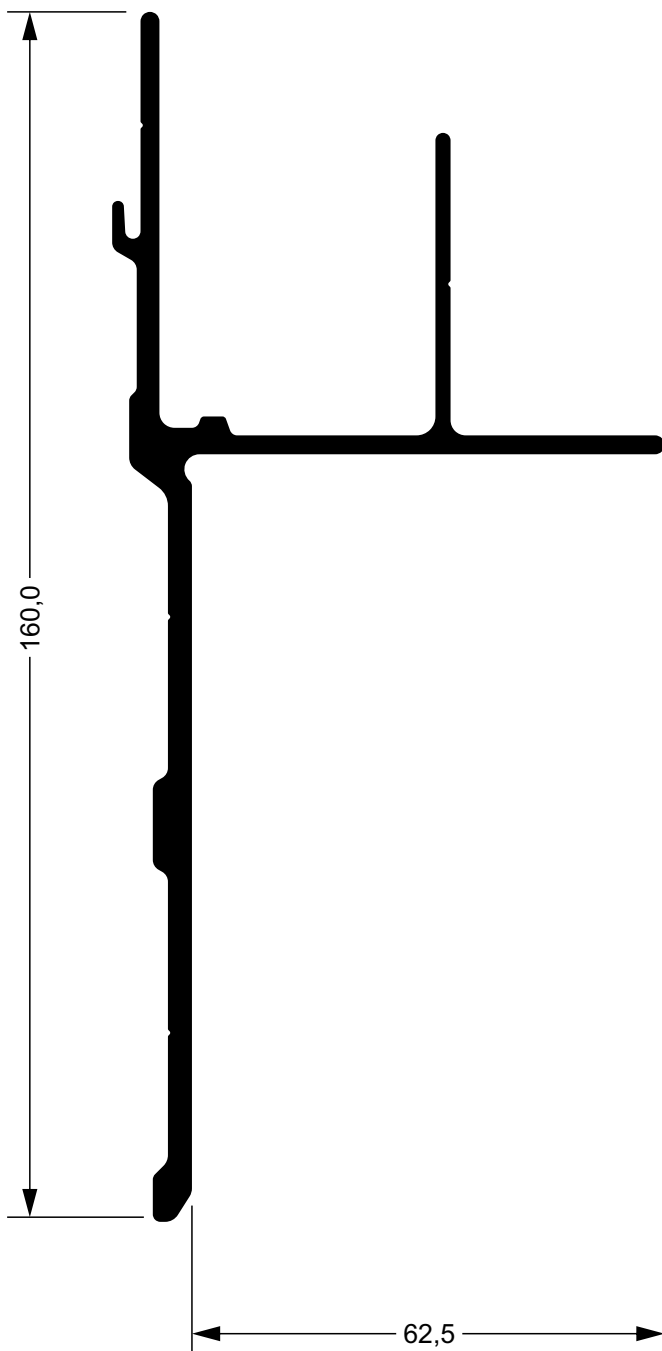

391496 D

2,215 kg/m

Longarina Inferior

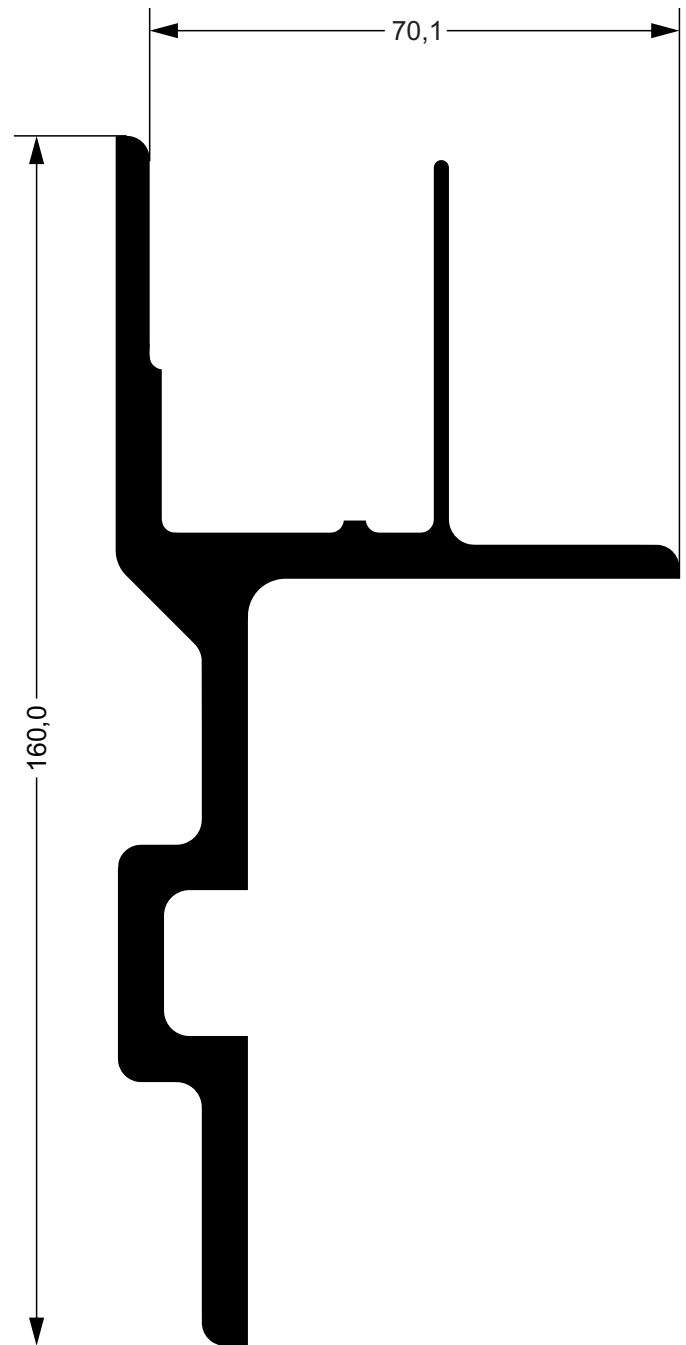

39325

4,470 Kg/m

Longarina Inferior Pesada

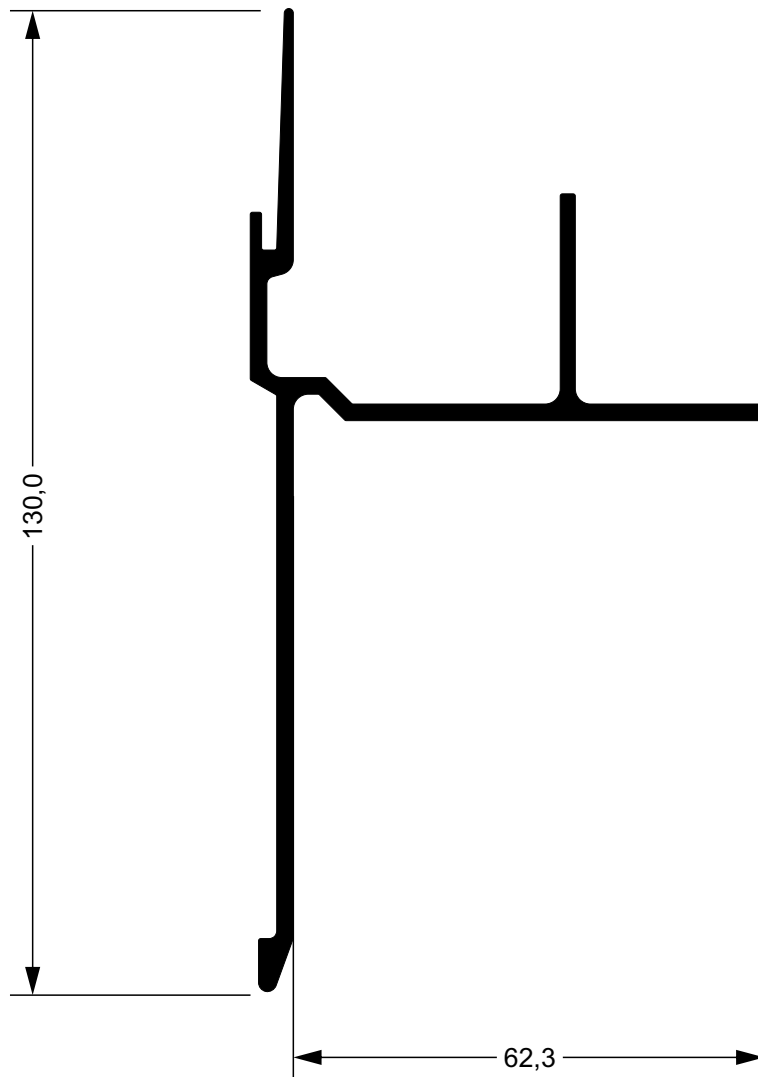

391664 D

1,354 kg/m

Longarina Inferior

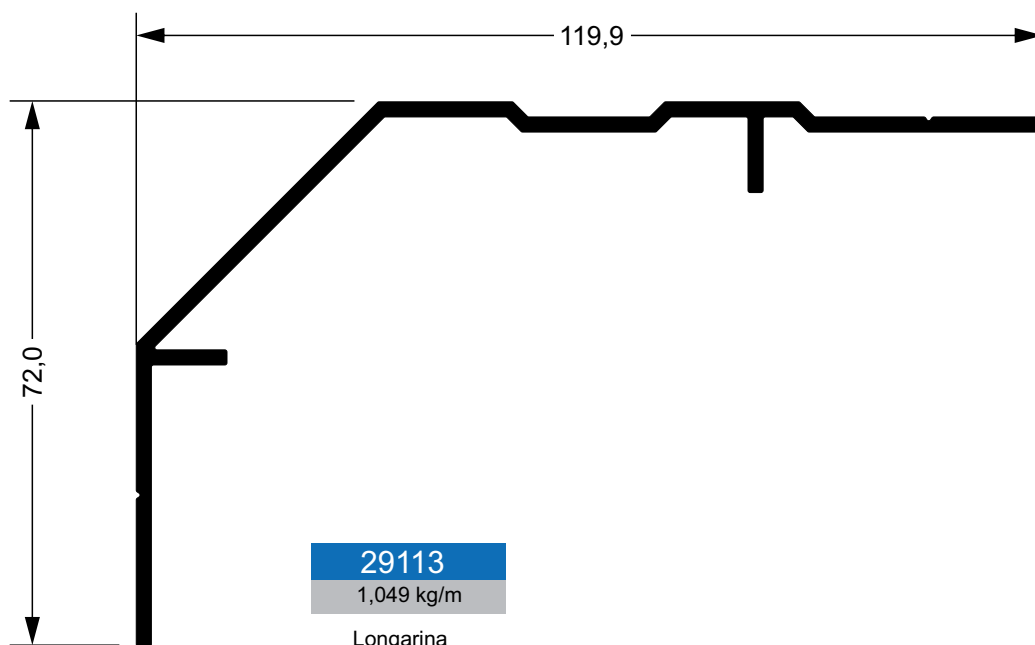

29113

1,049 kg/m

Longarina

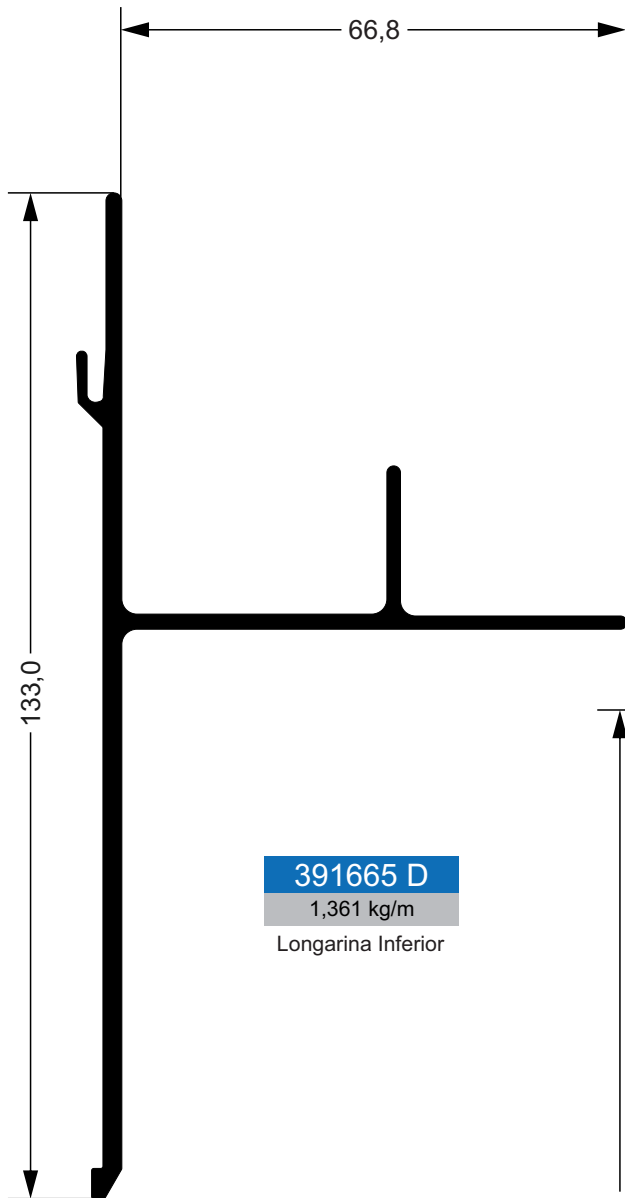

391665 D
1,361 kg/m
Longarina Inferior

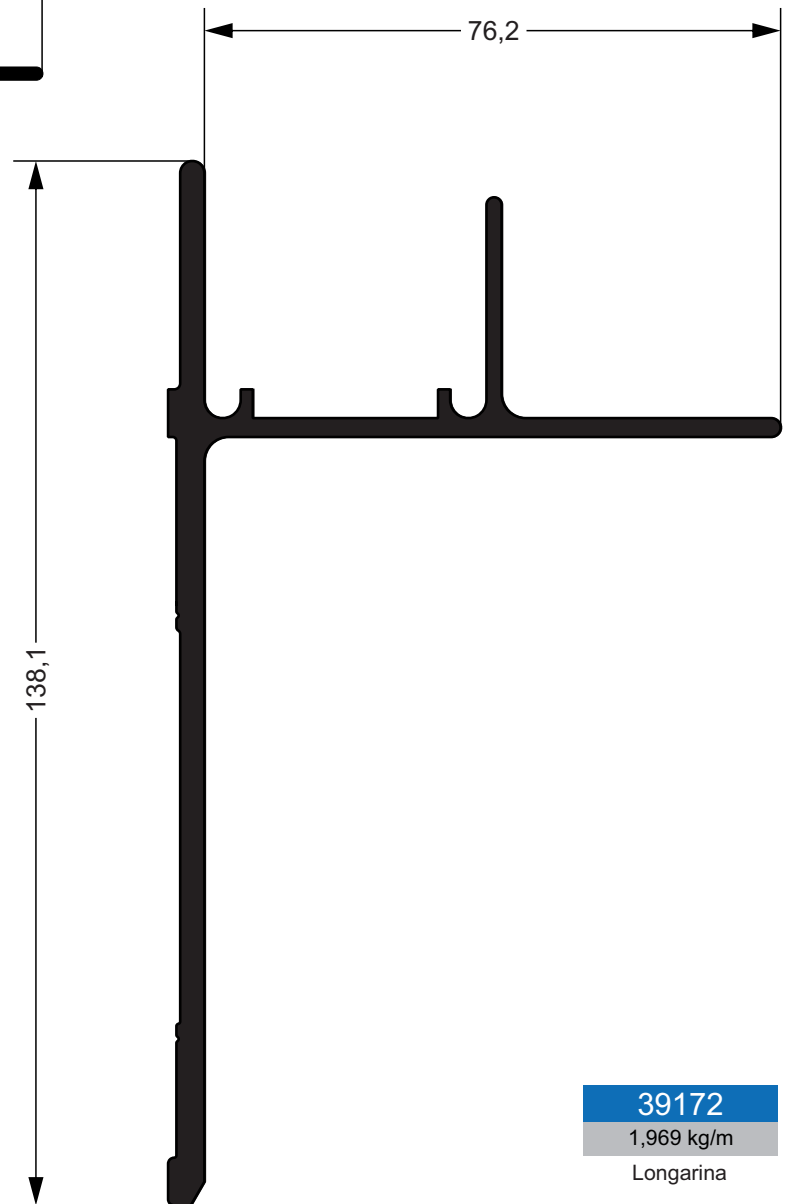

39172
1,969 kg/m
Longarina

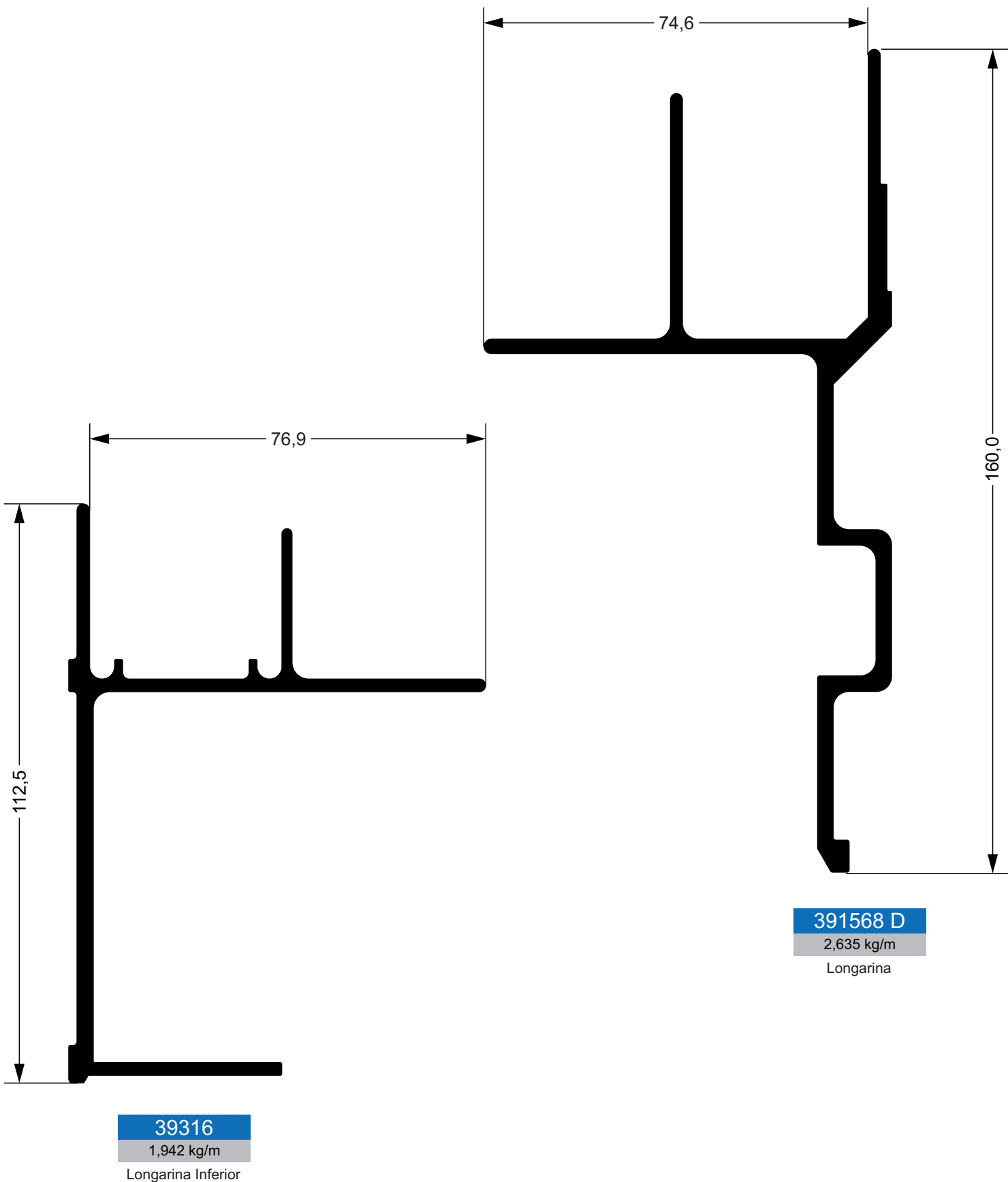

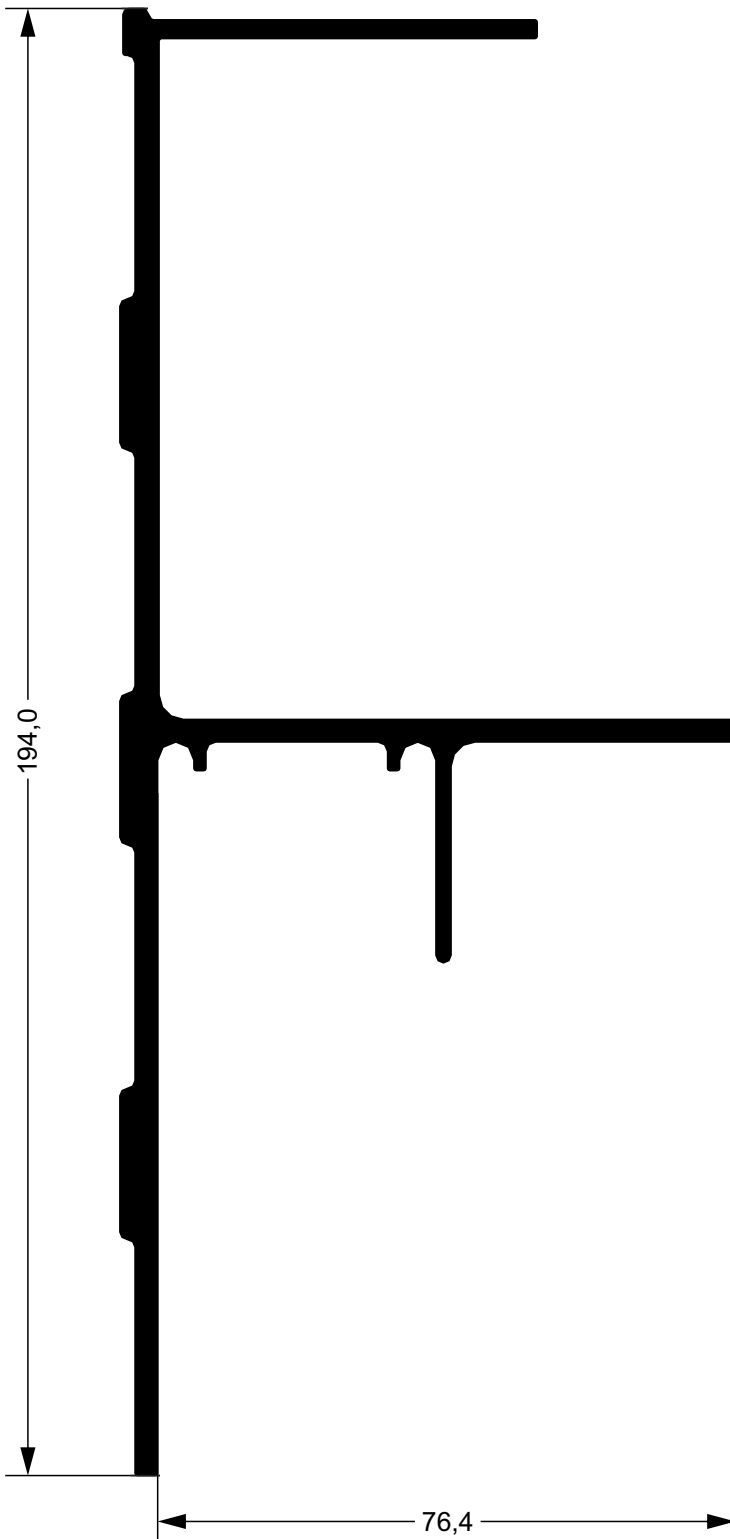

392067 C

3,151 kg/m

Longarina

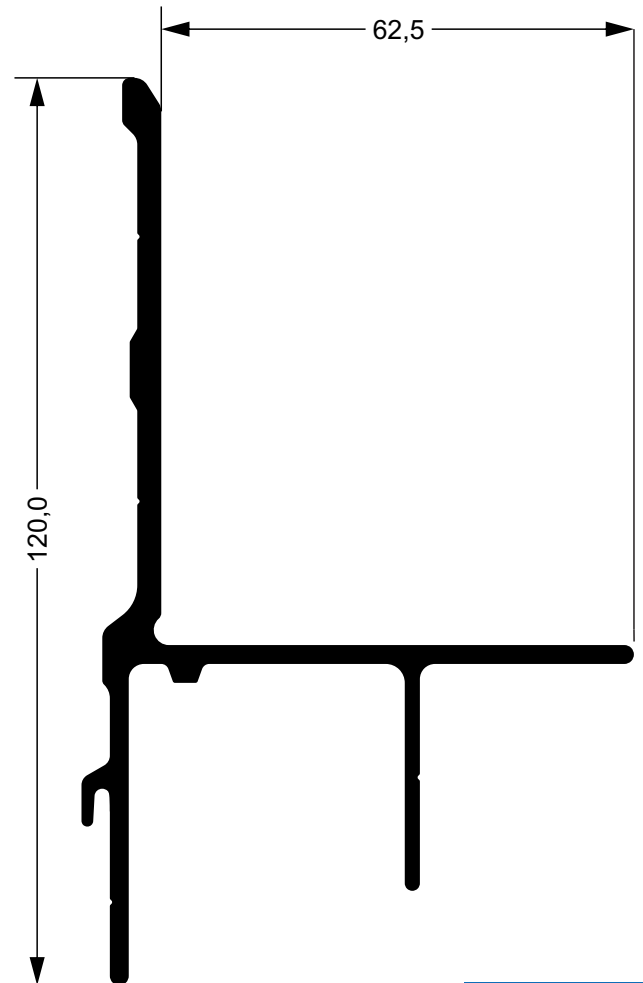

391497C

1,748 kg/m

Longarina Superior

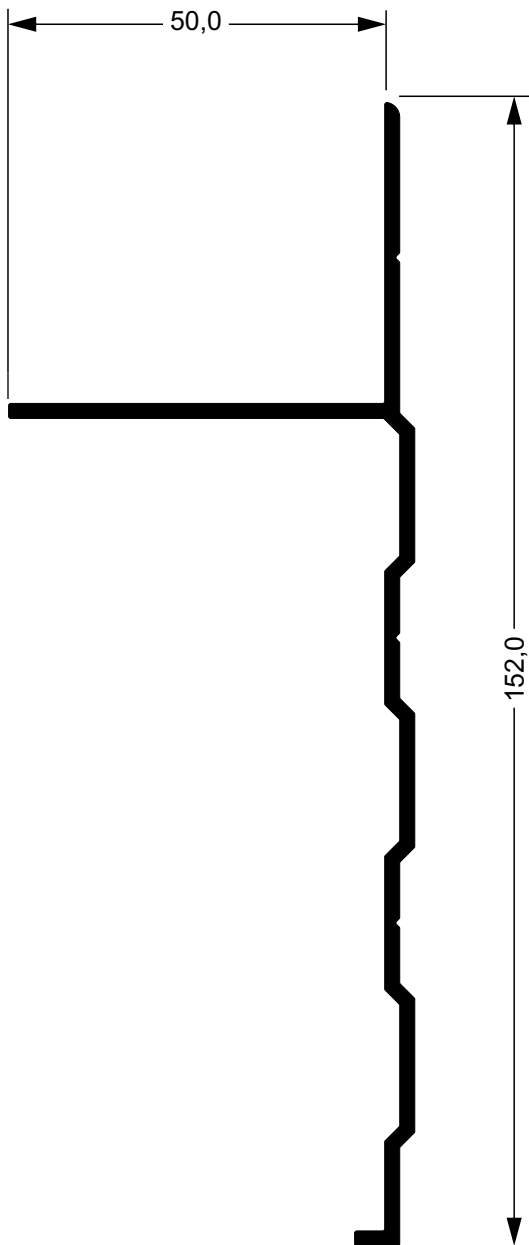

29112
1,138 kg/m
Longarina Inferior

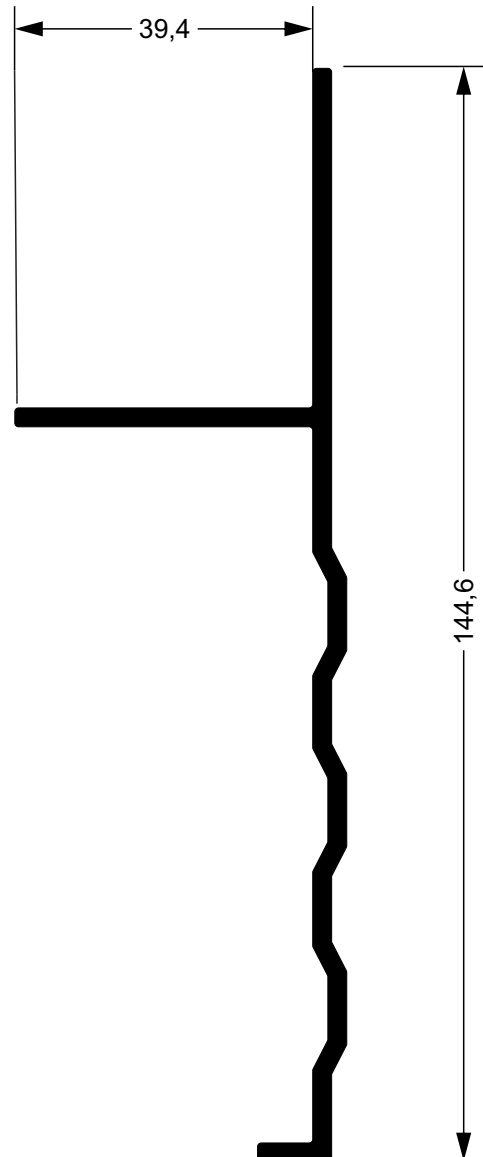

391187 C
1,314 kg/m
Longarina Inferior

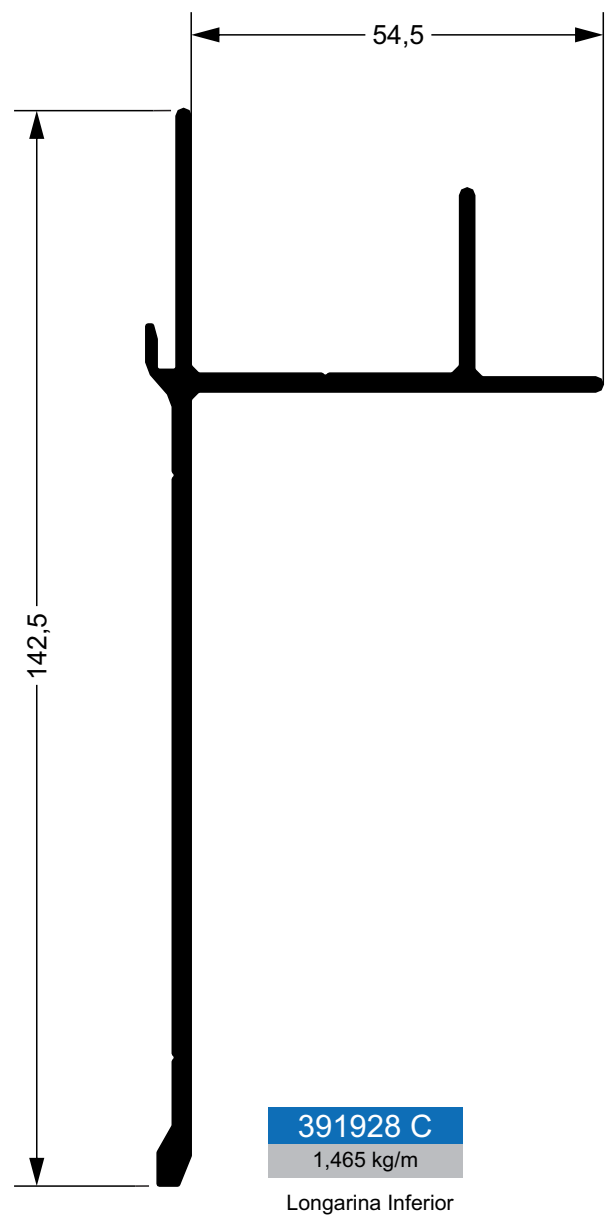
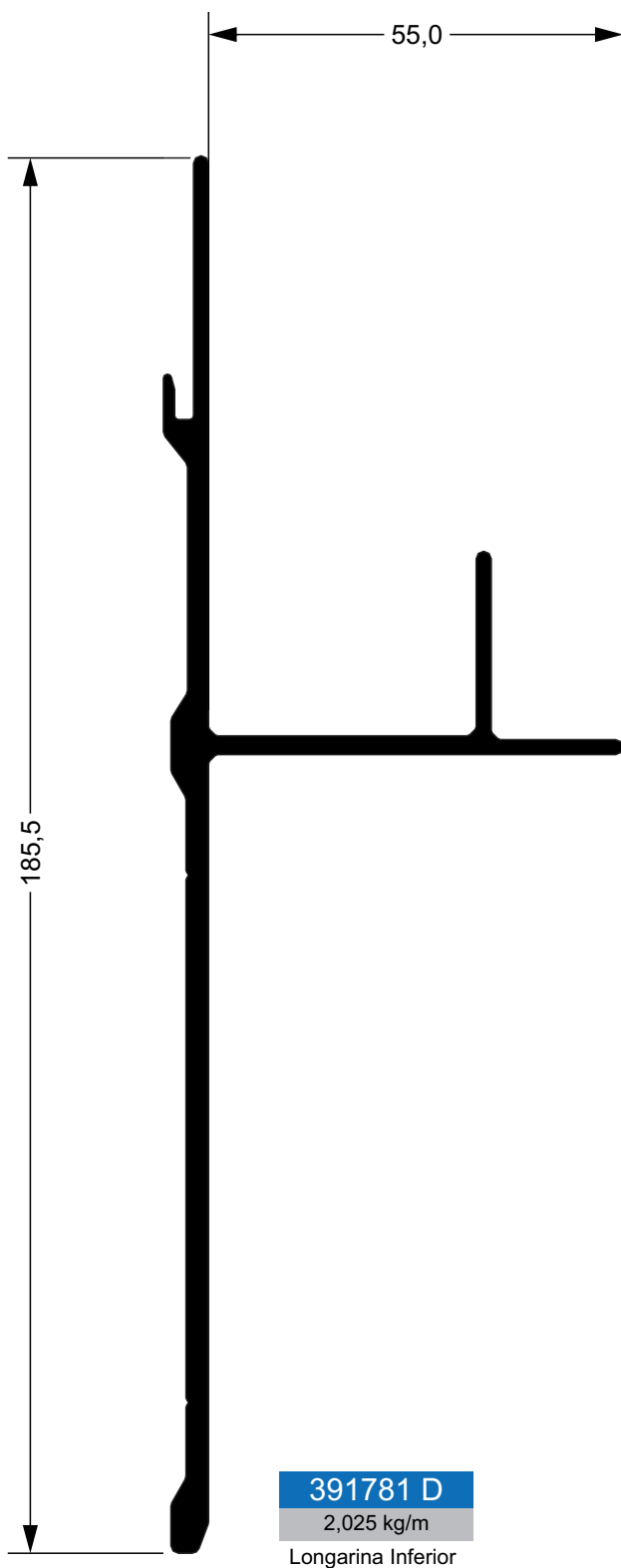

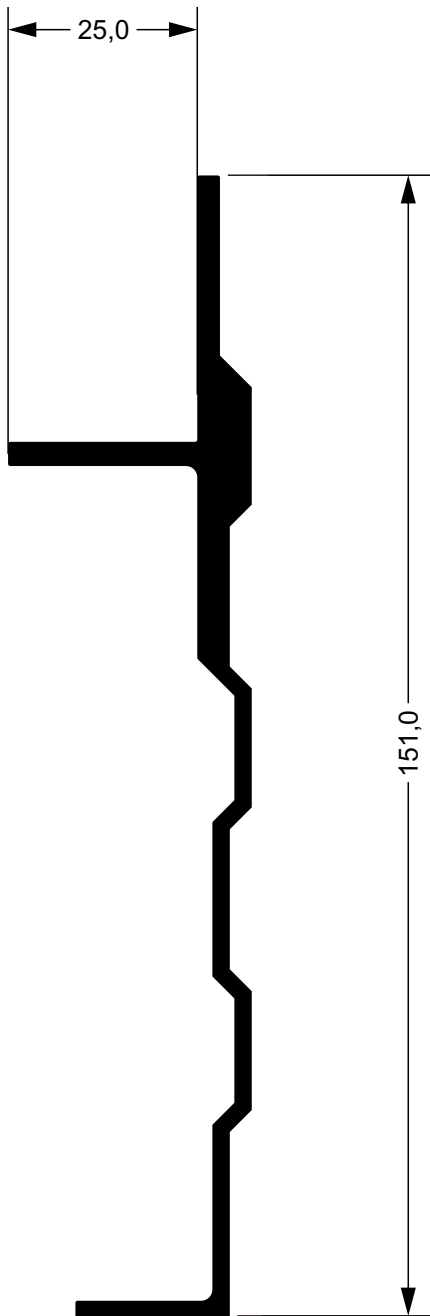

19364
1,712 kg/m
Longarina Inferior

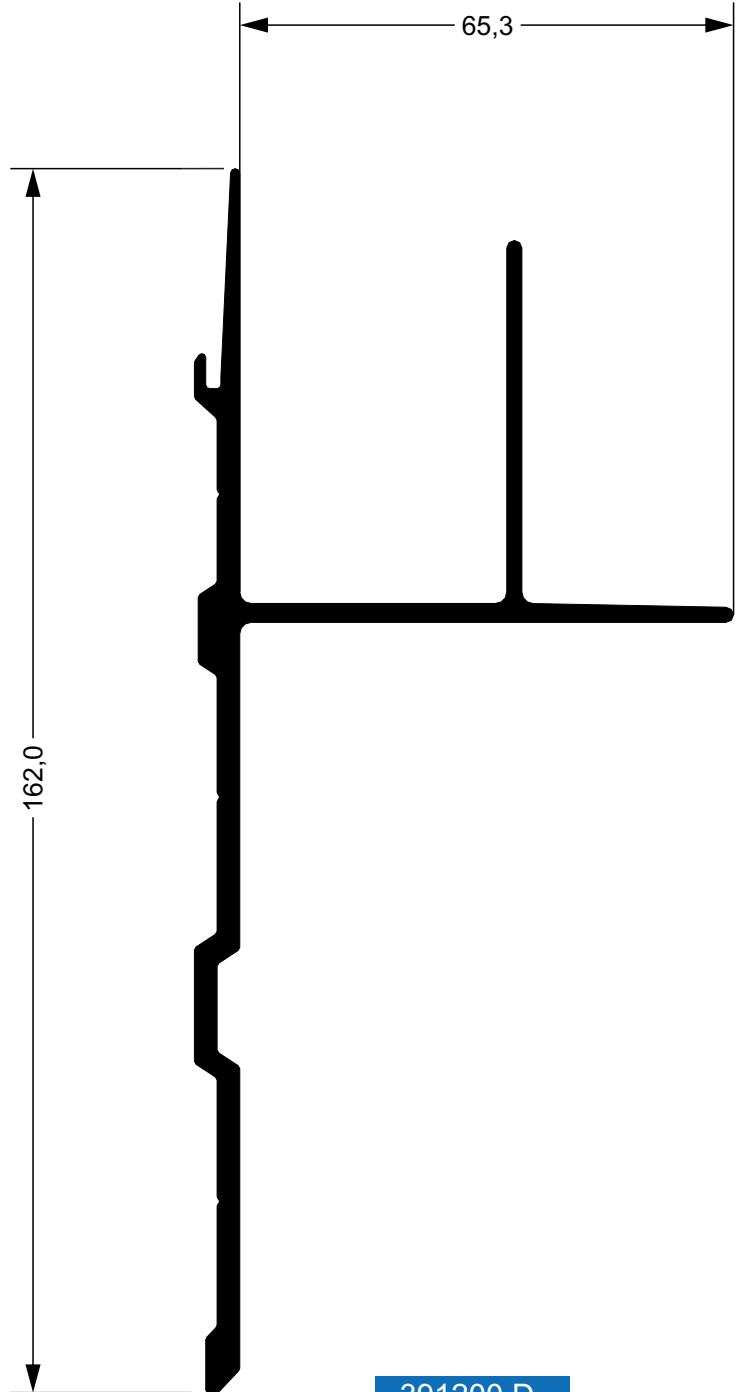

391200 D
2,073 kg/m
Longarina

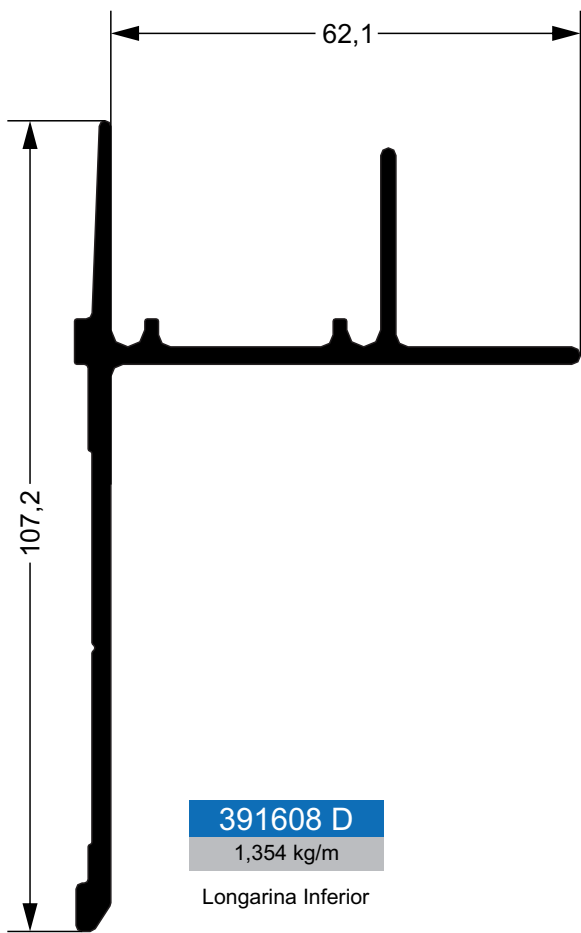

391608 D

1,354 kg/m

Longarina Inferior

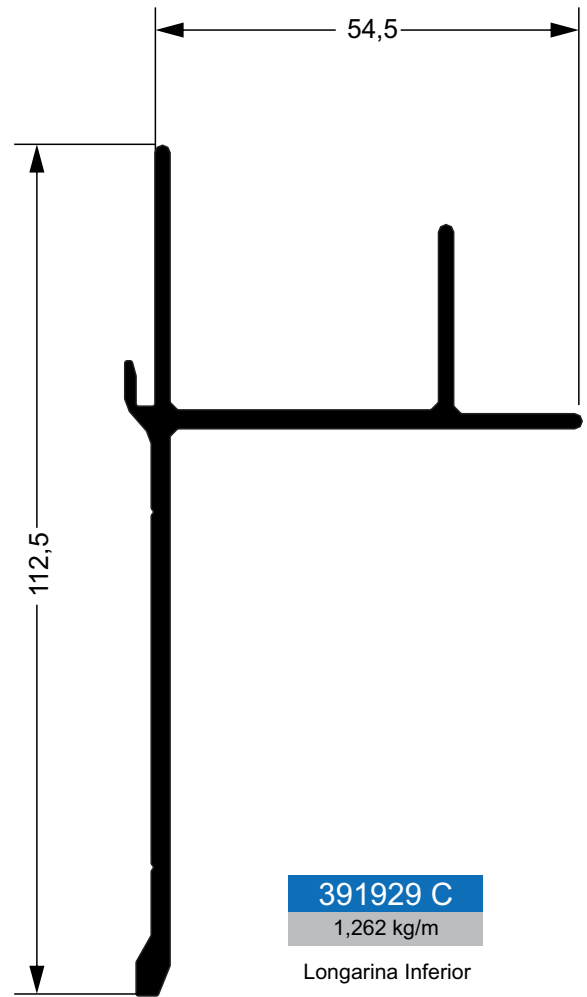

391929 C

1,262 kg/m

Longarina Inferior

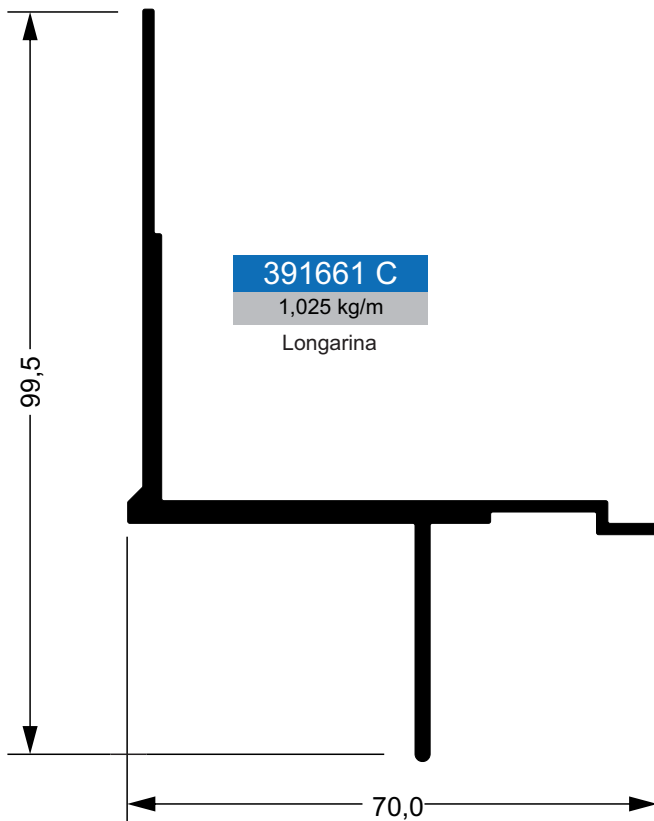

391661 C

1,025 kg/m

Longarina

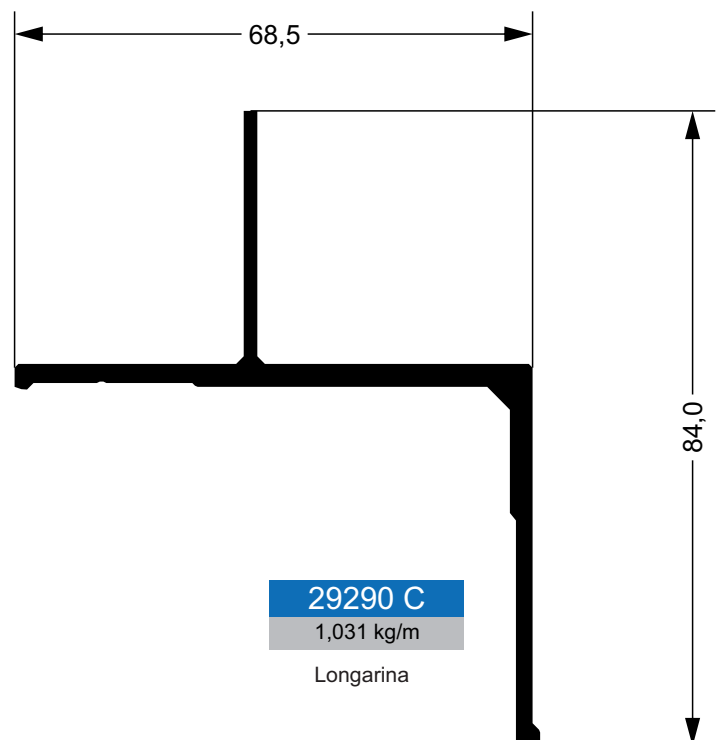

29290 C

1,031 kg/m

Longarina

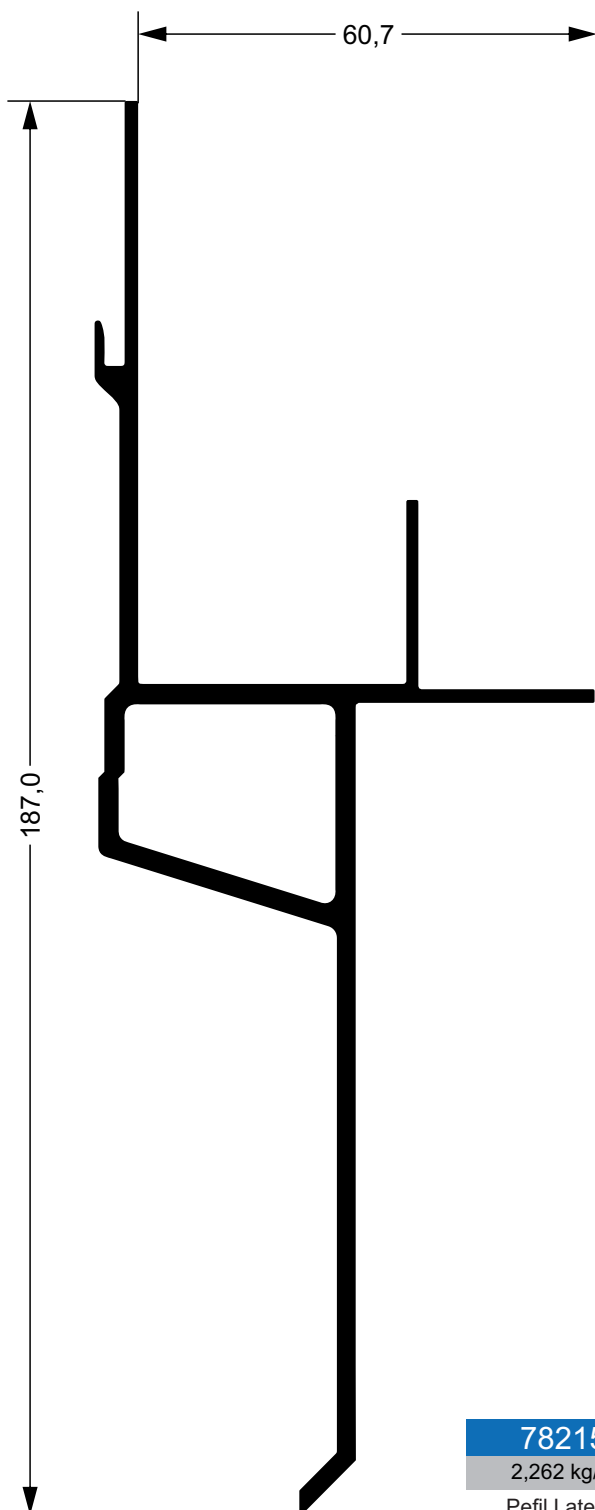

78215
2,262 kg/m
Perfil Lateral

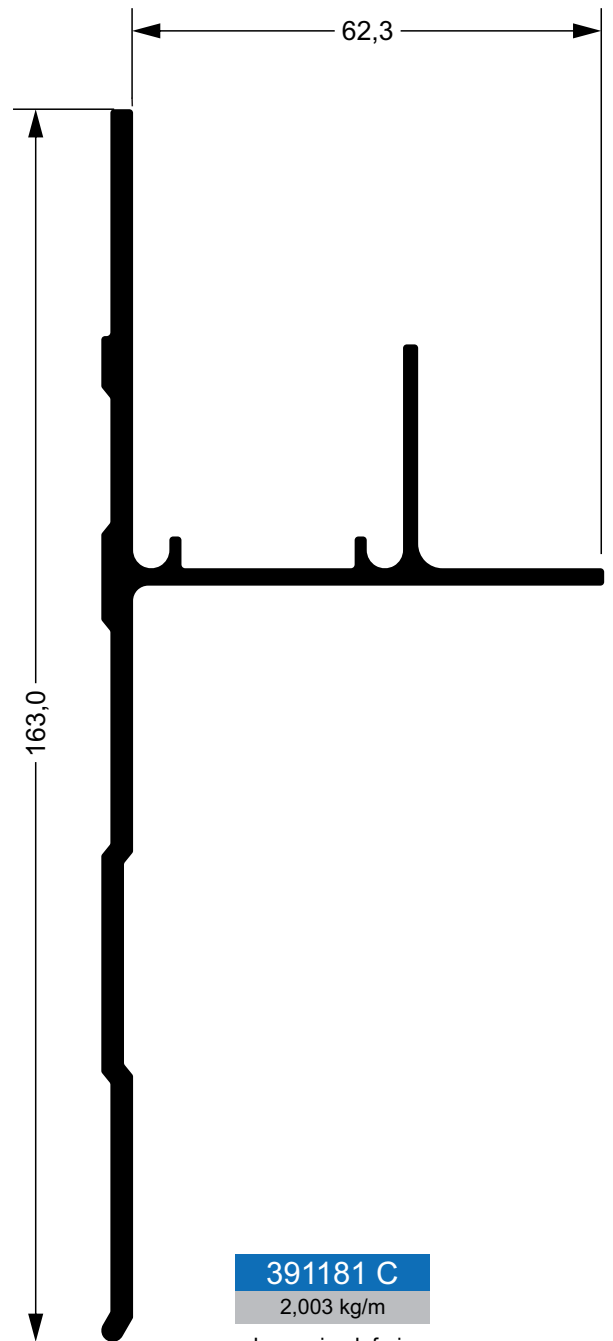

391181 C
2,003 kg/m
Longarina Inferior

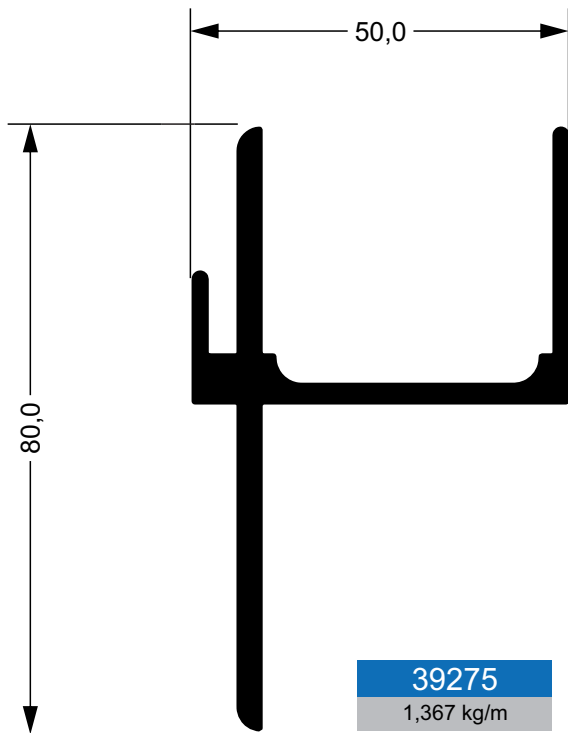

39275

1,367 kg/m

Perfil Lateral

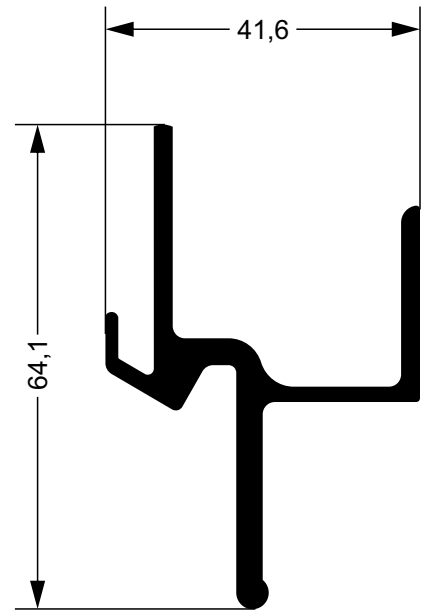

39315

1,053 kg/m

Perfil Lateral

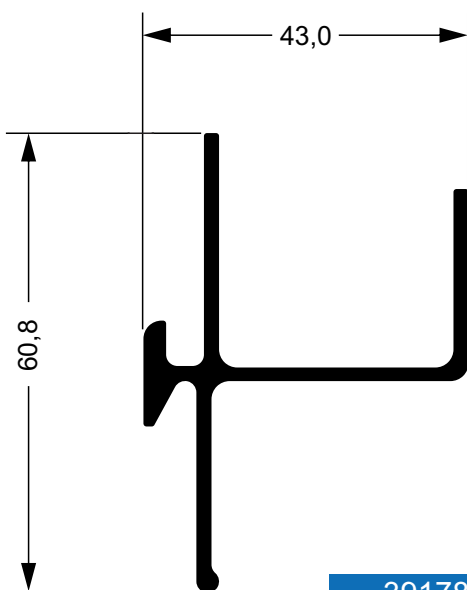

39178

0,777 kg/m

Perfil Lateral

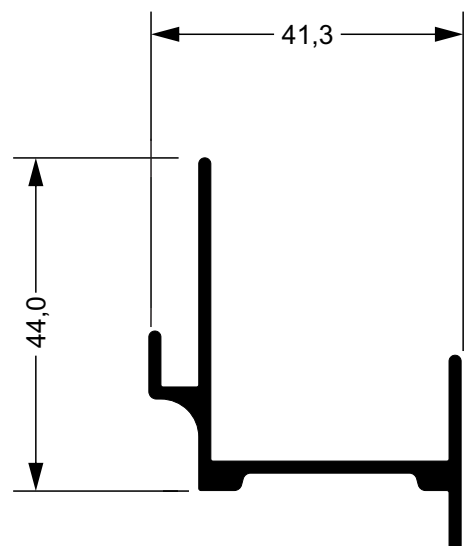

391660 C

0,564 kg/m

Perfil Lateral

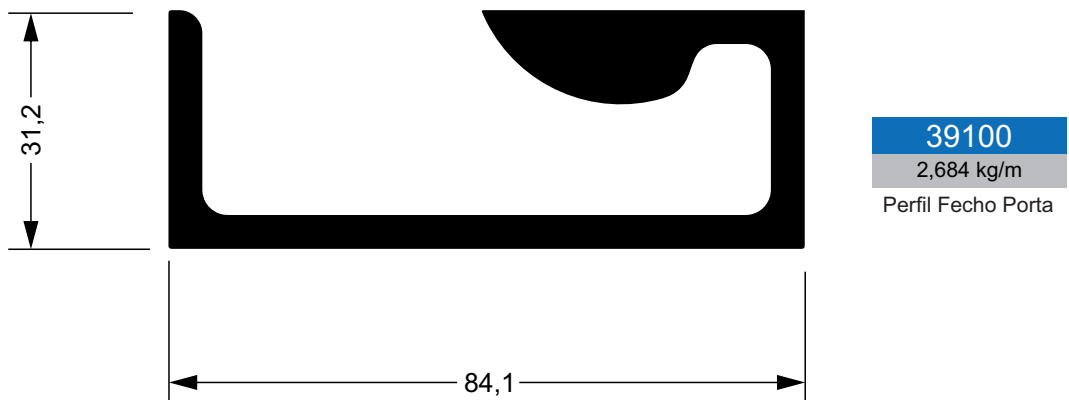
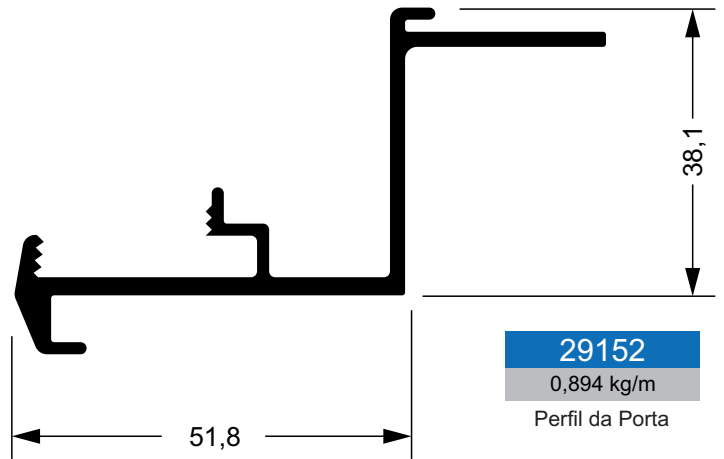
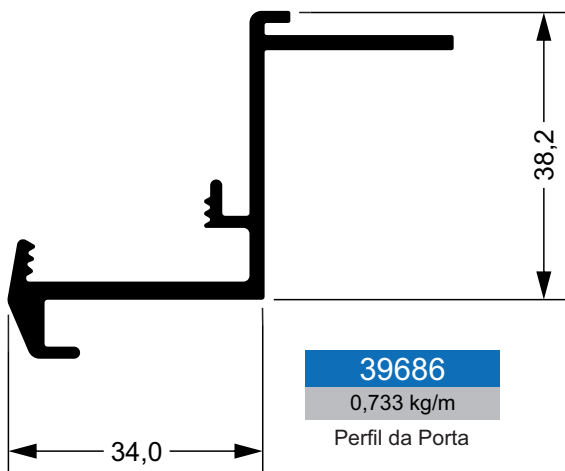
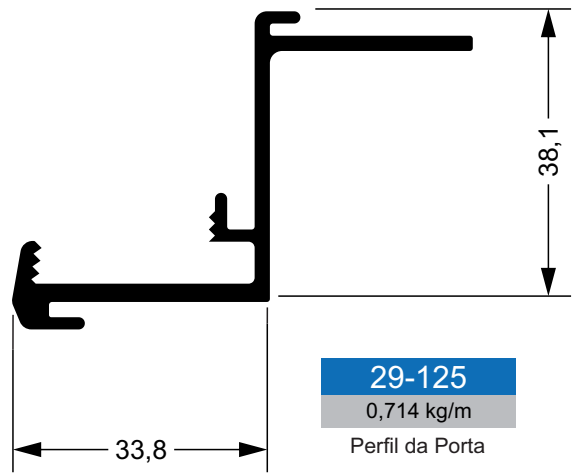
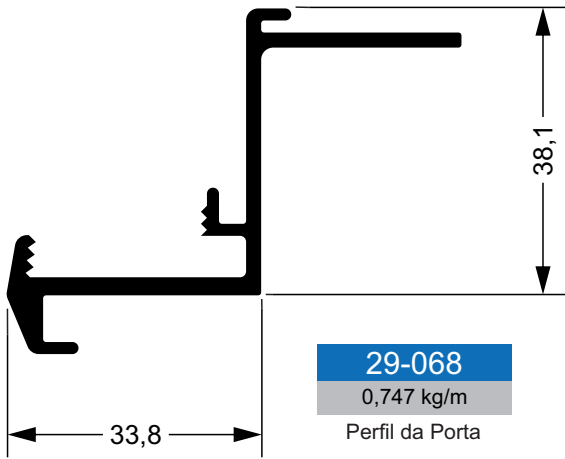

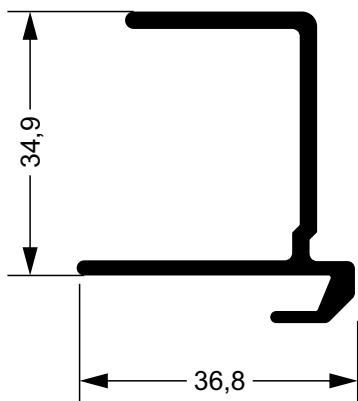

39687

0,627 kg/m

Perfil Lateral

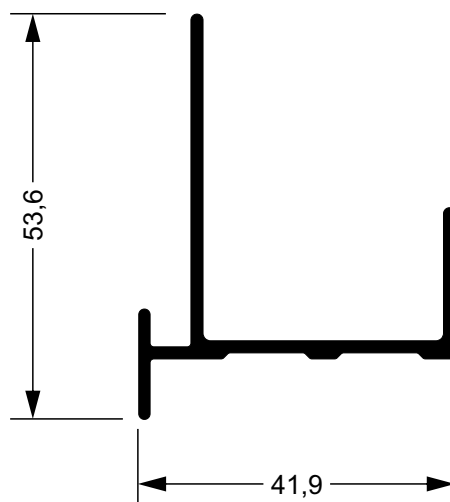

391440 C

0,525 kg/m

Acabamento Lateral

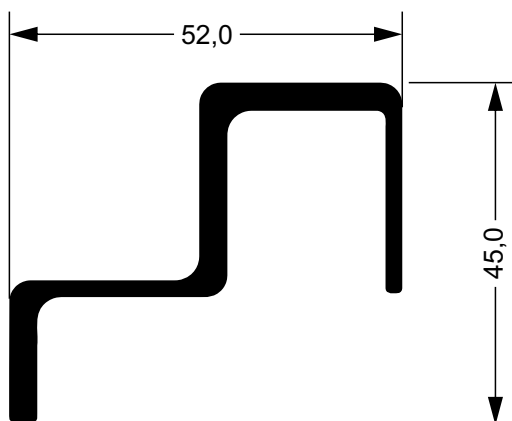

39103

1,062 kg/m

Perfil Lateral
Quadro Lateral

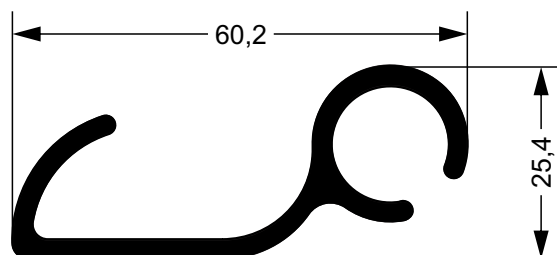

65269D

0,729 kg/m

Perfil Lateral Sider

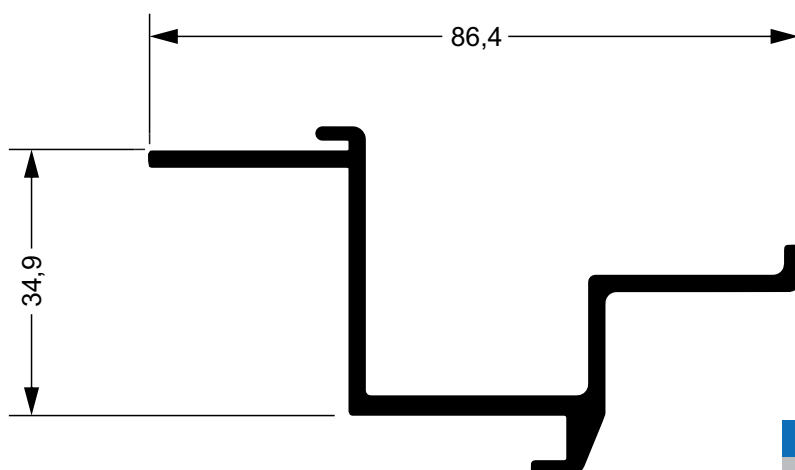

39313

0,913 kg/m

Perfil Batente Porta

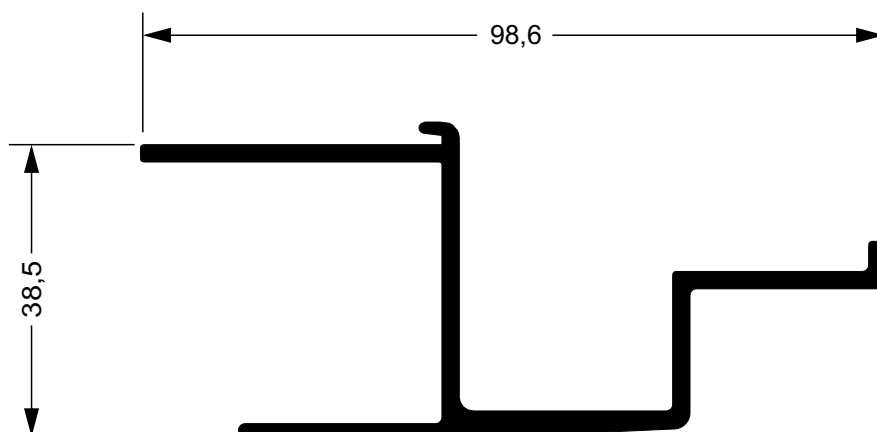

39339

1,046 kg/m

Perfil Batente Porta

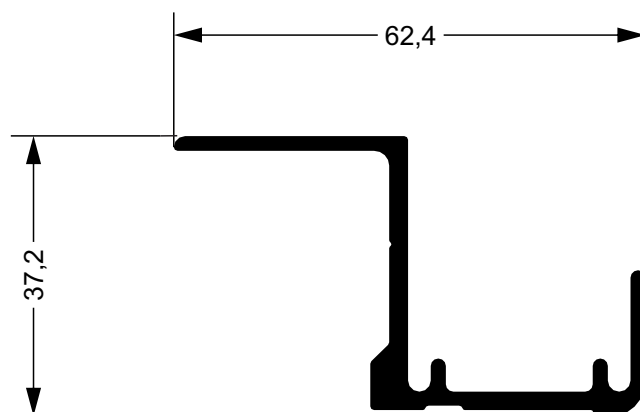

391198 C

0,809 kg/m

Perfil Batente Porta

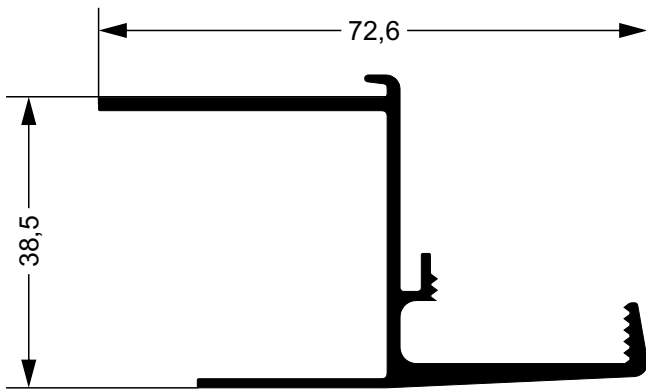

39340
0,870 kg/m
Perfil Porta

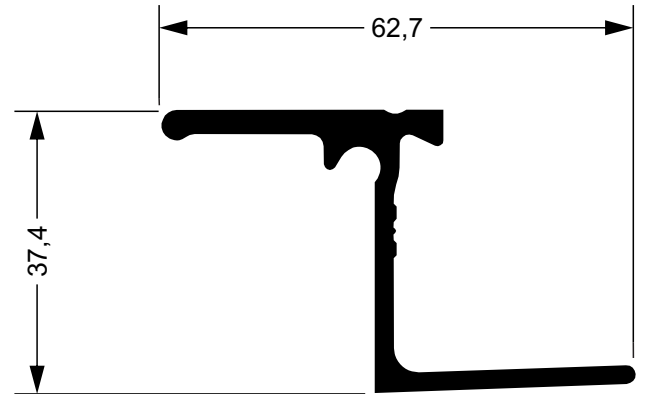

40005
0,852 kg/m
Perfil Teto

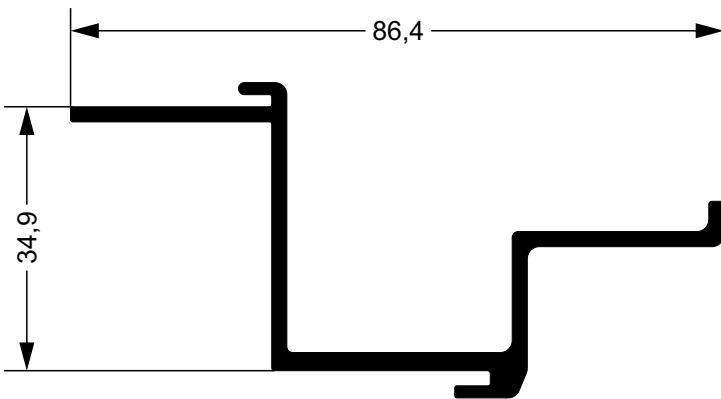

39577
0,886 kg/m
Perfil Batente Porta

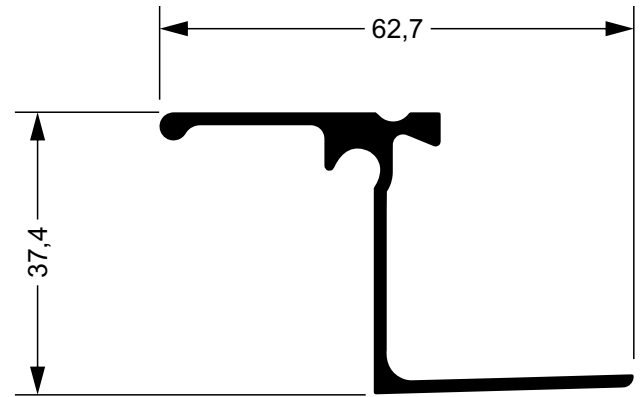

40007
0,700 kg/m
Perfil Teto

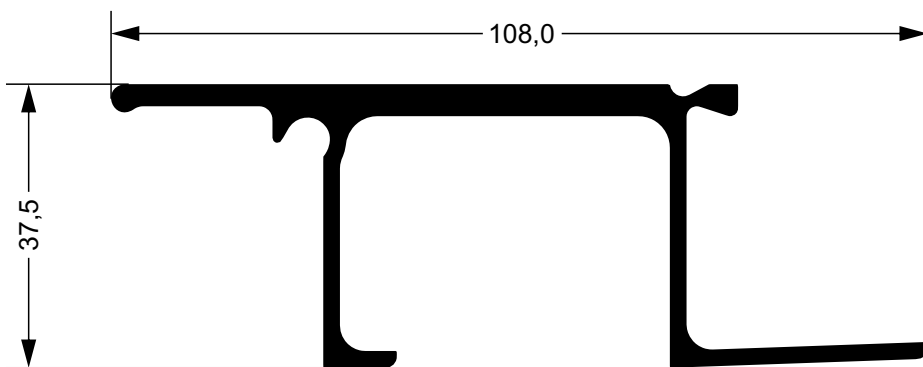

39173
1,681 kg/m
Perfil Teto

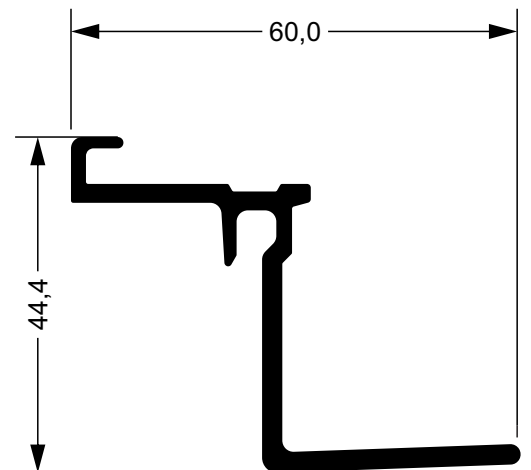

39685
0,797 kg/m
Perfil Teto

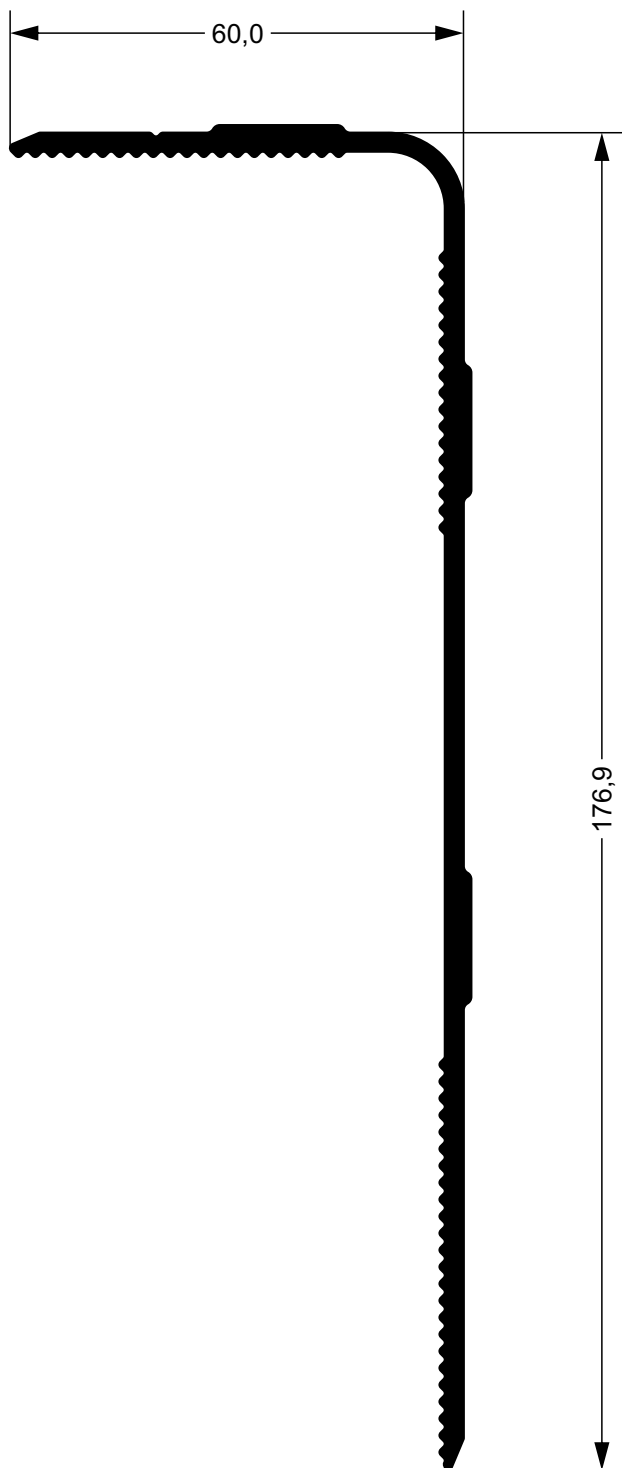

29274 D
1,811 kg/m
Saia Externa Grande

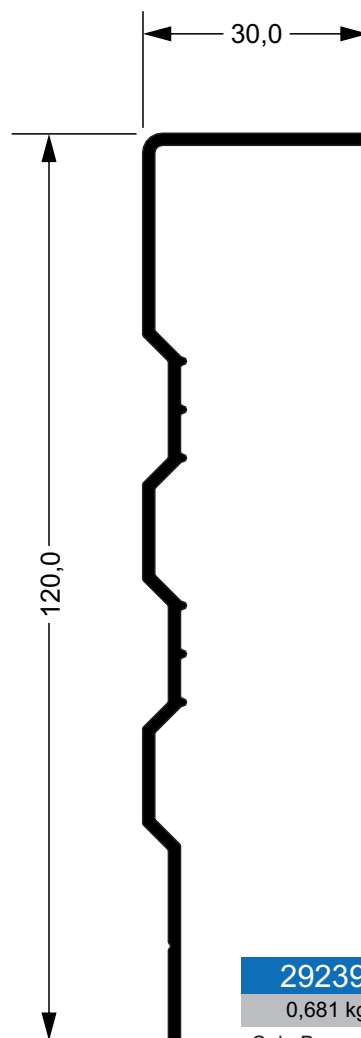

29239 C
0,681 kg/m
Saia Barranqueira

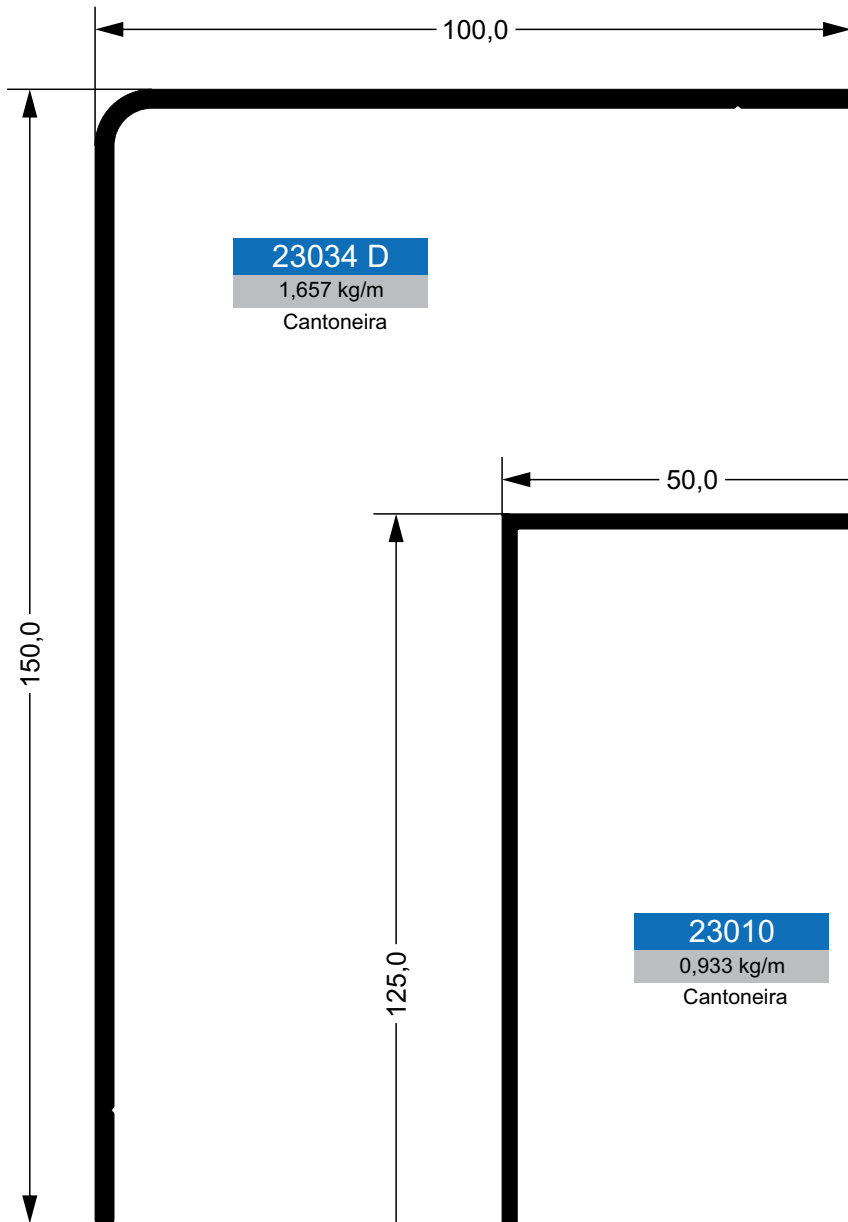

23034 D
1,657 kg/m
Cantoneira

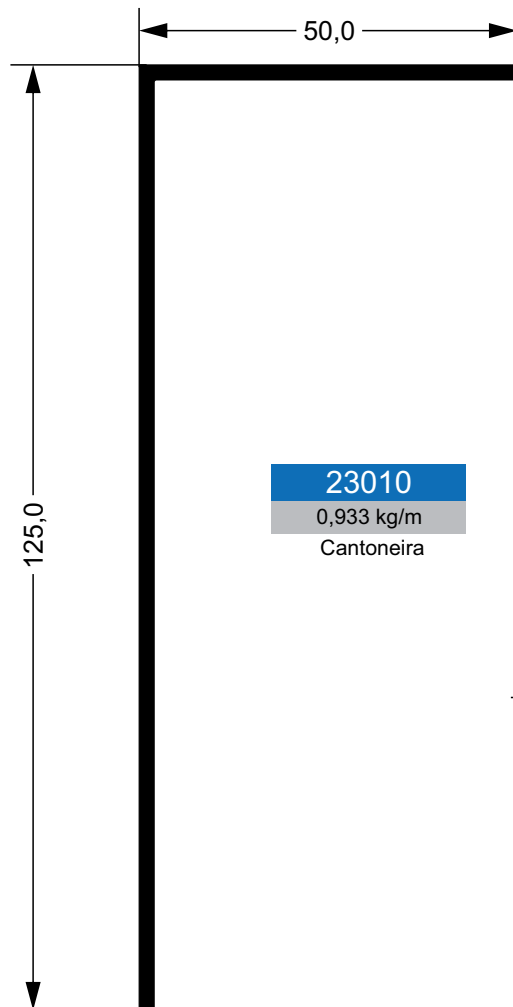

23010
0,933 kg/m
Cantoneira

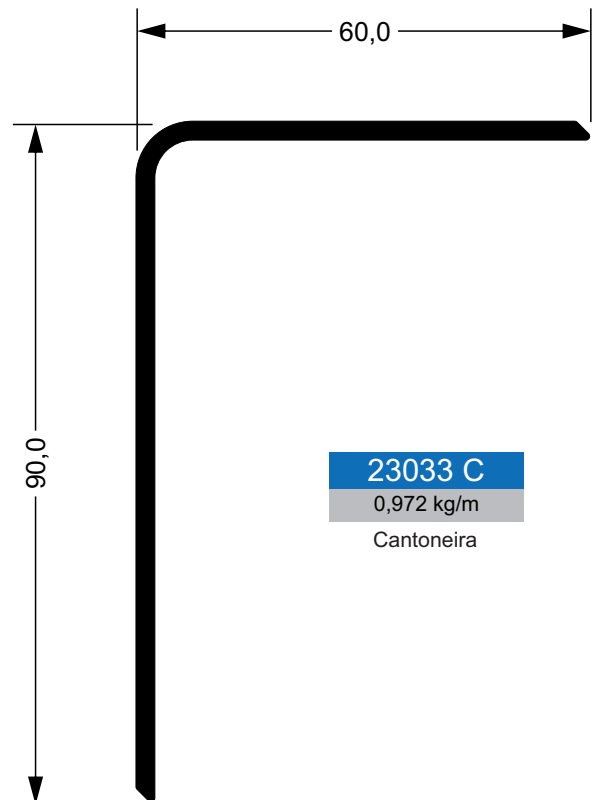

23033 C
0,972 kg/m
Cantoneira

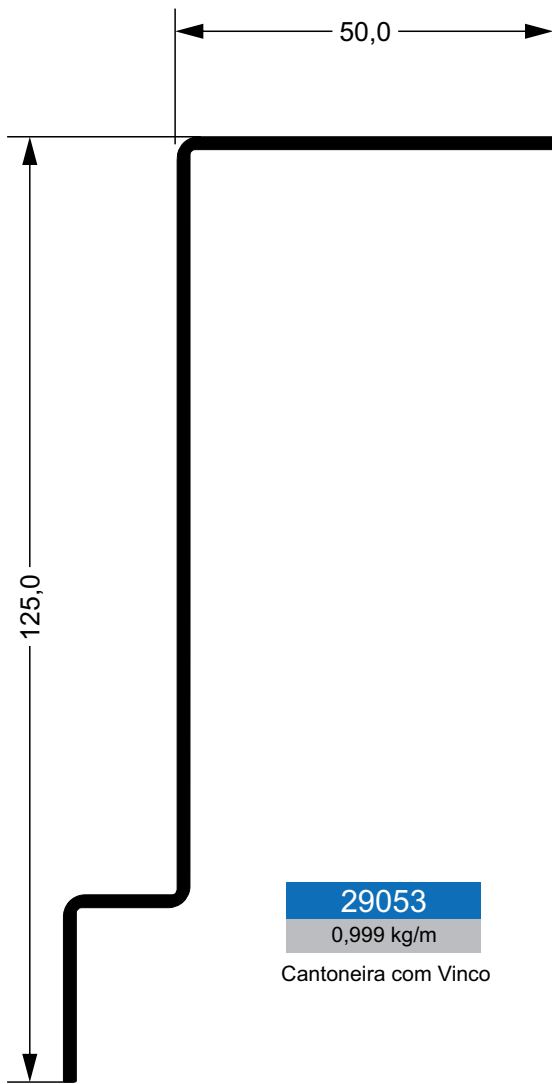

29053
0,999 kg/m
Cantoneira com Vinco

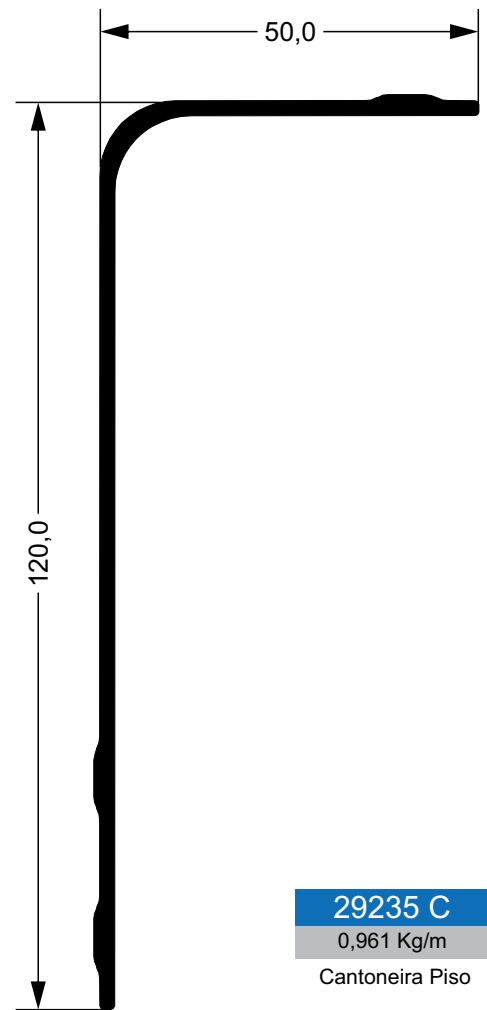

29235 C
0,961 Kg/m
Cantoneira Piso

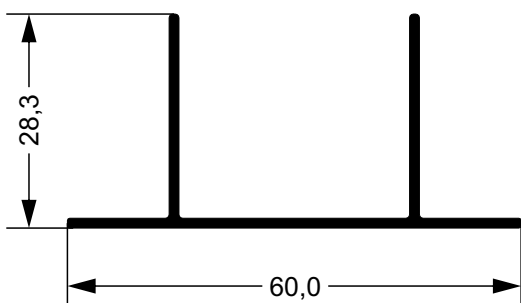

35015 C
0,401 kg/m
Suporte Vertical
Protetor Lateral

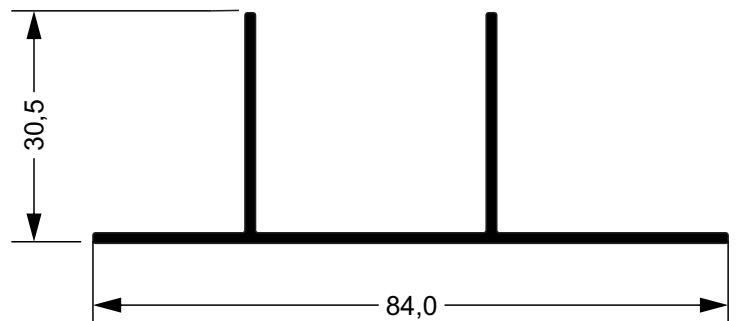

391613 C
0,538 kg/m
Suporte Vertical
Protetor Lateral

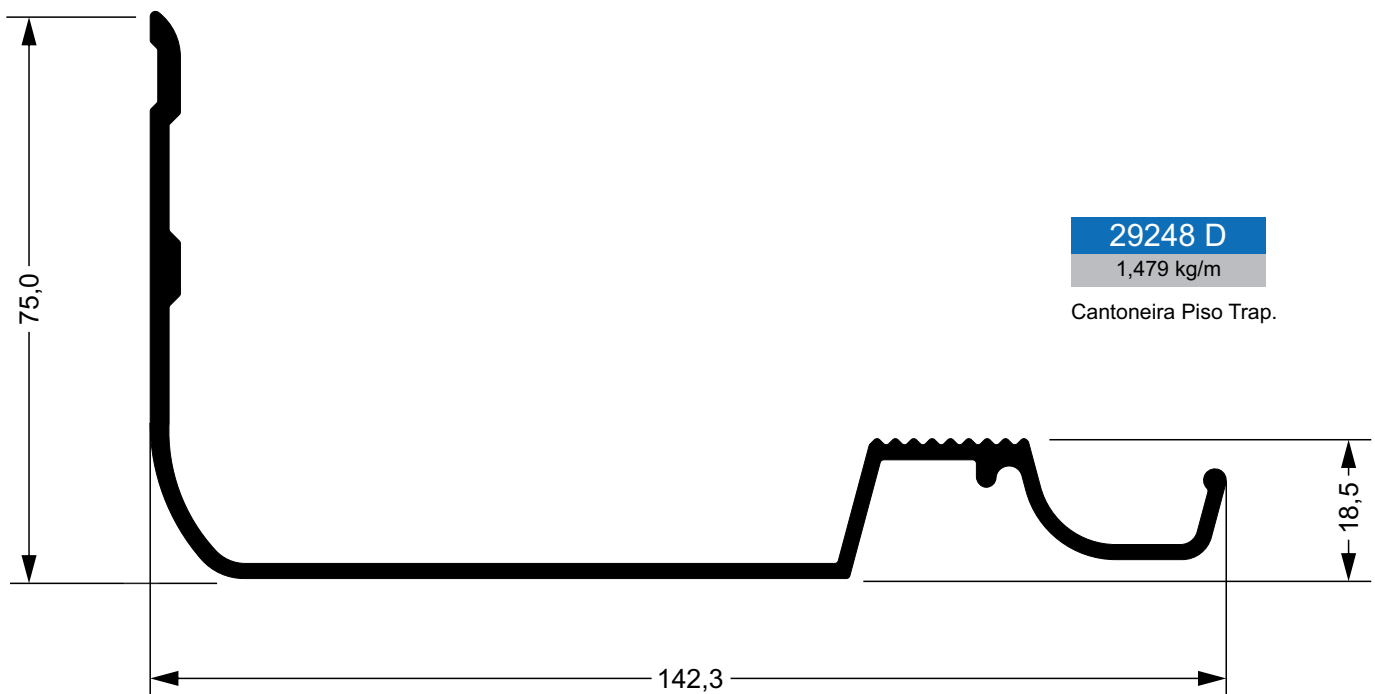
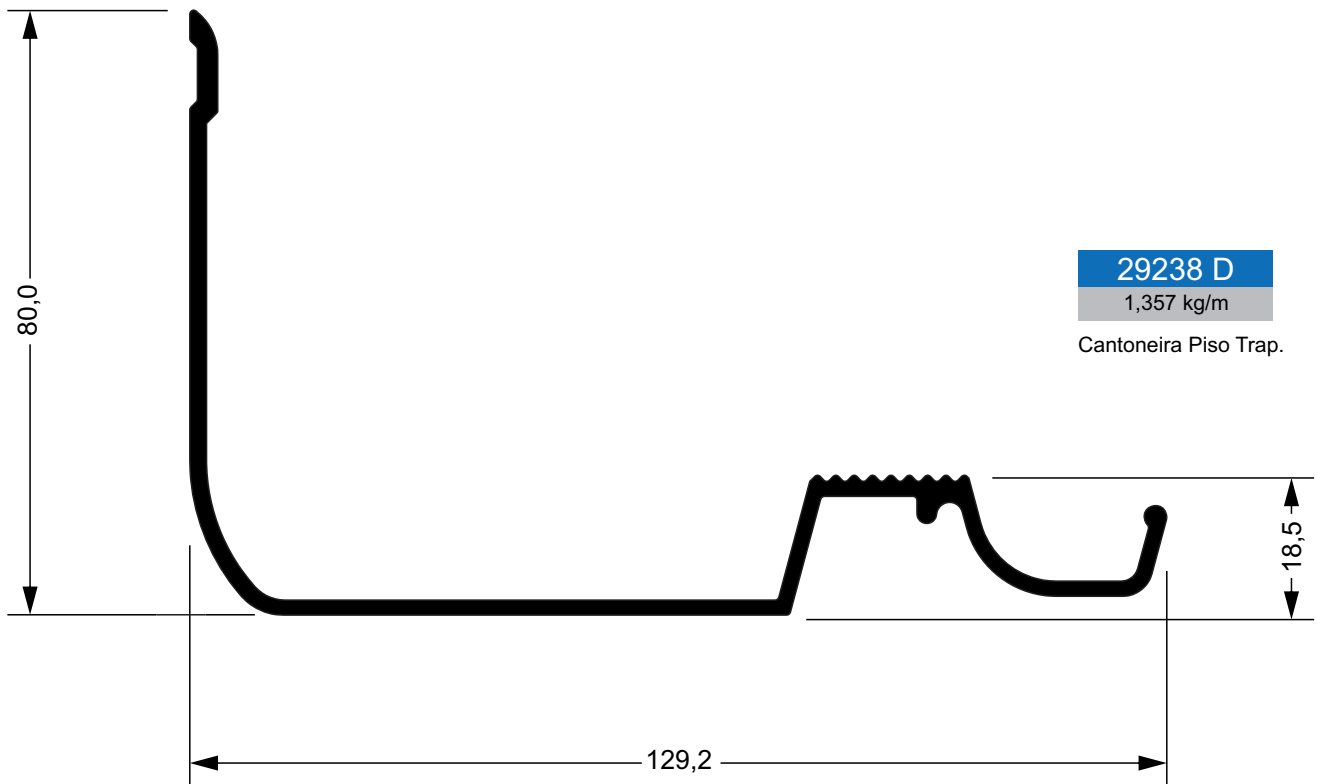

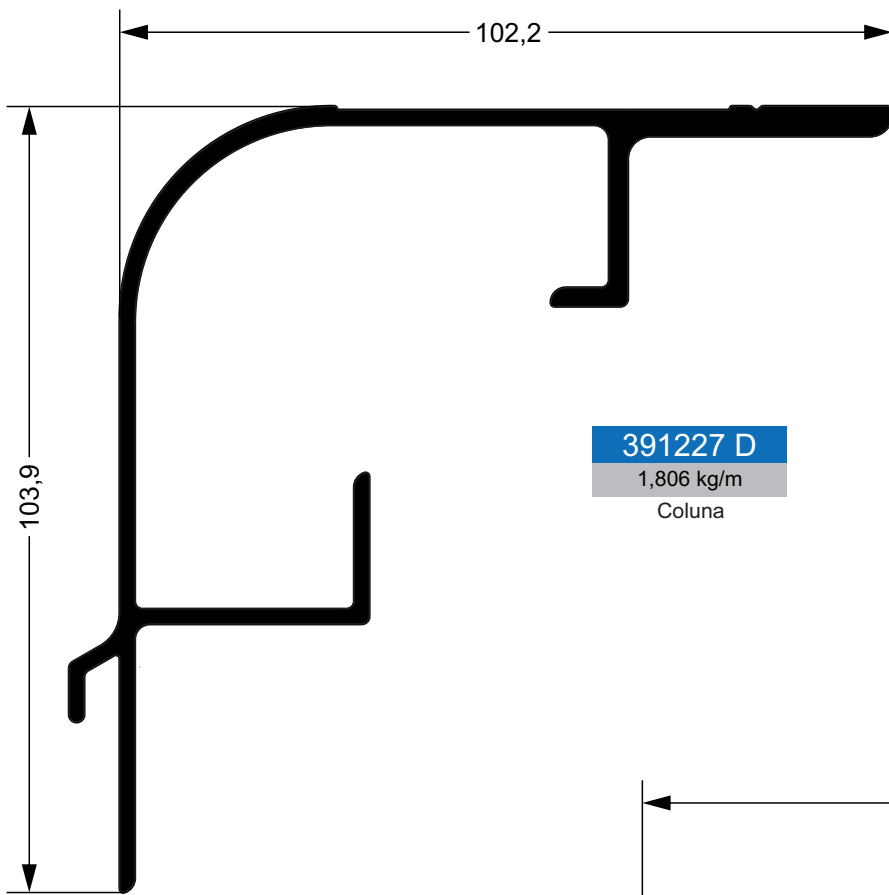

391227 D

1,806 kg/m

Coluna

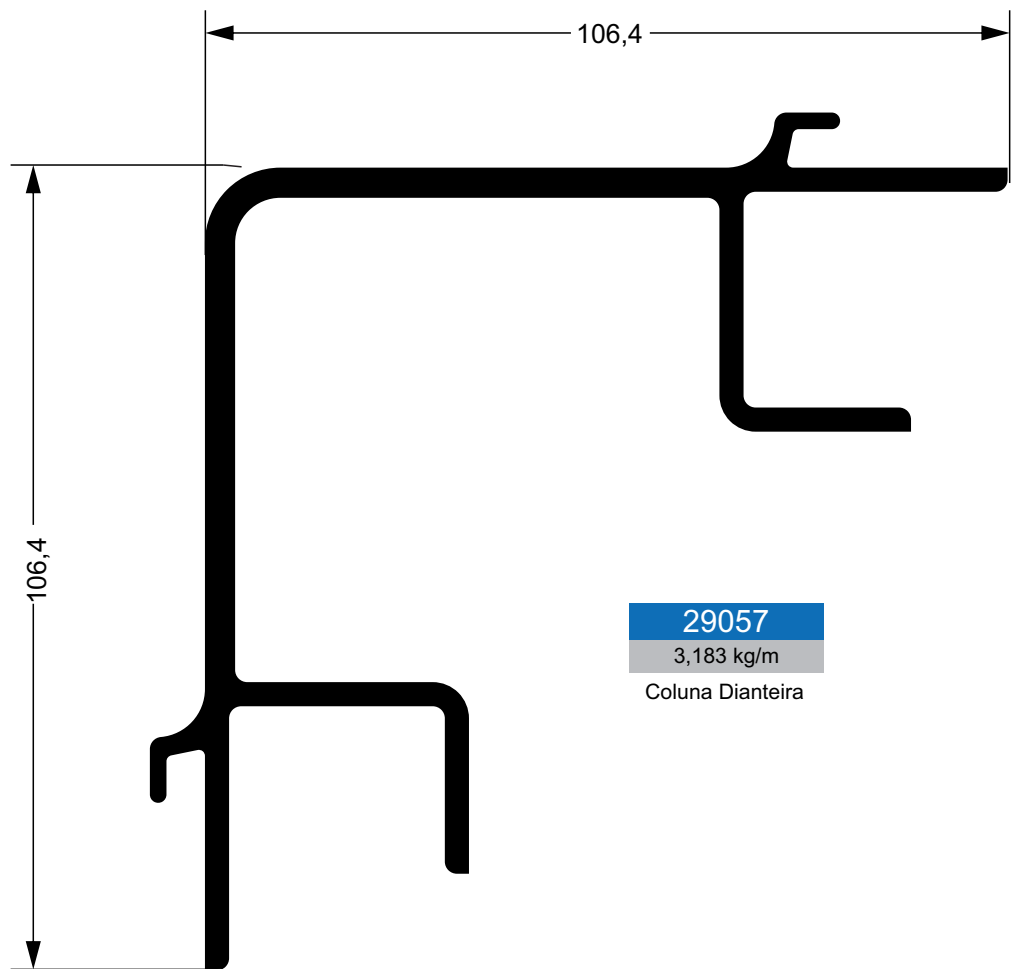

29057

3,183 kg/m

Coluna Dianteira

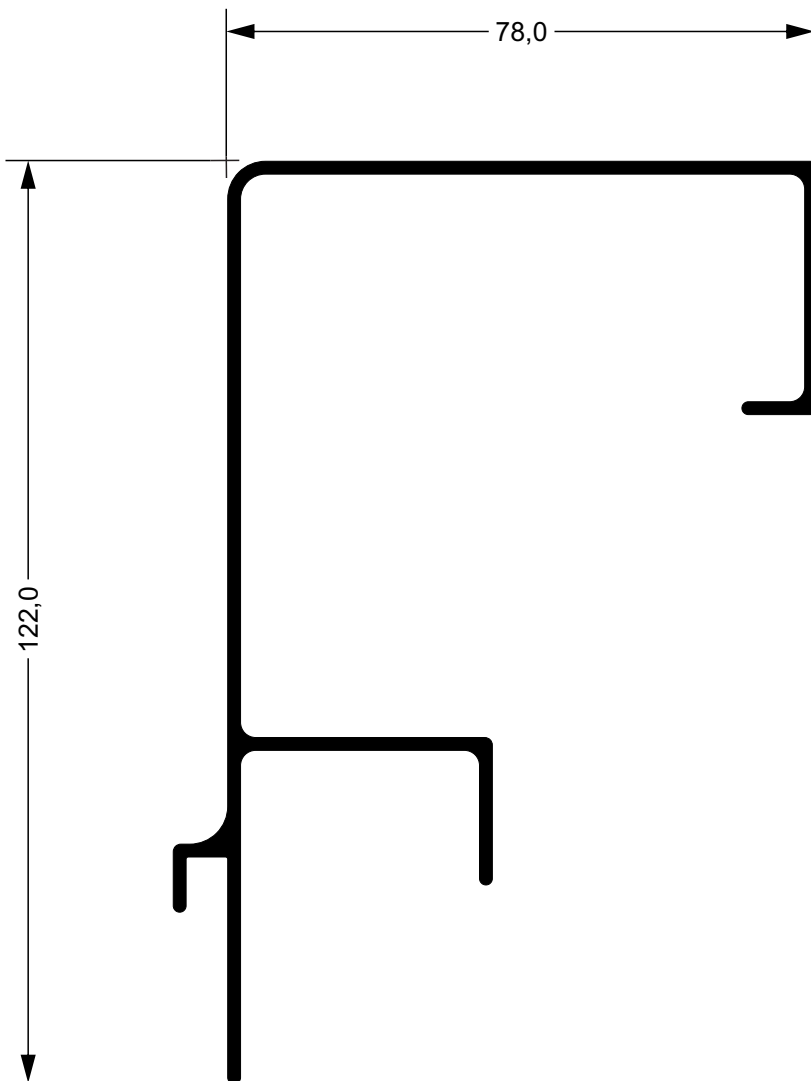

391662 D

1,412 kg/m

Coluna

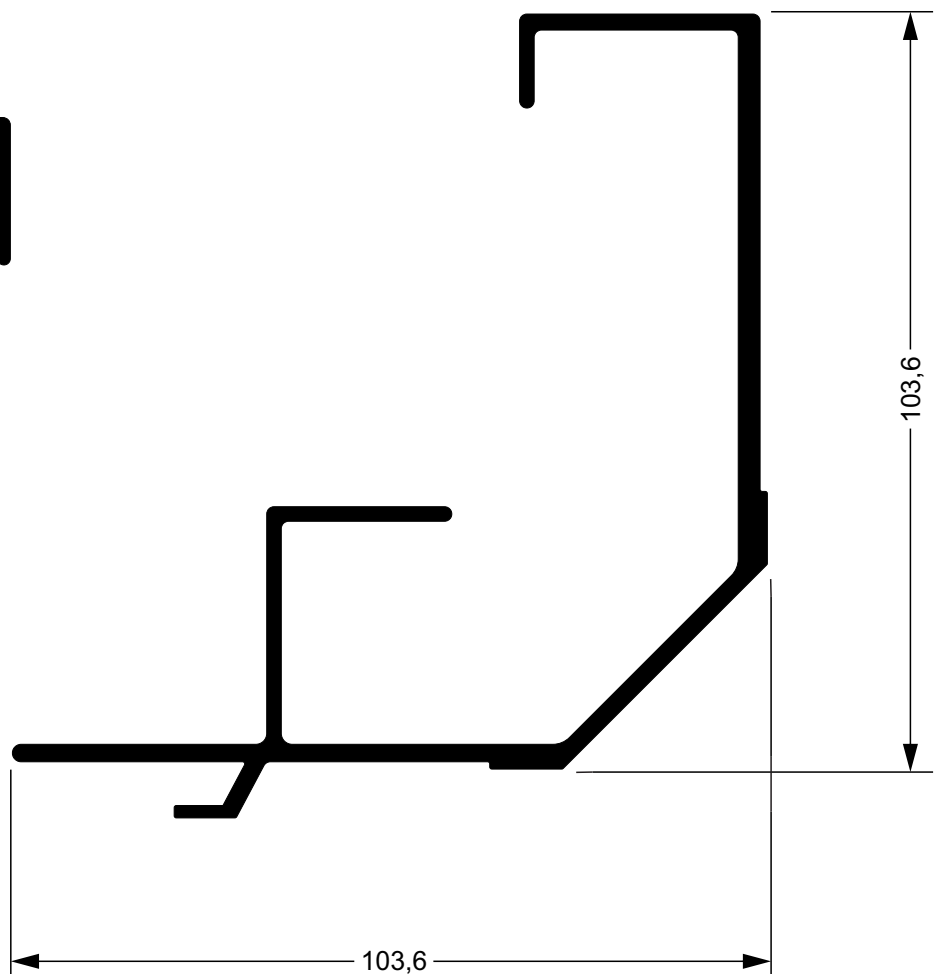

39688

2,028 kg/m

Coluna

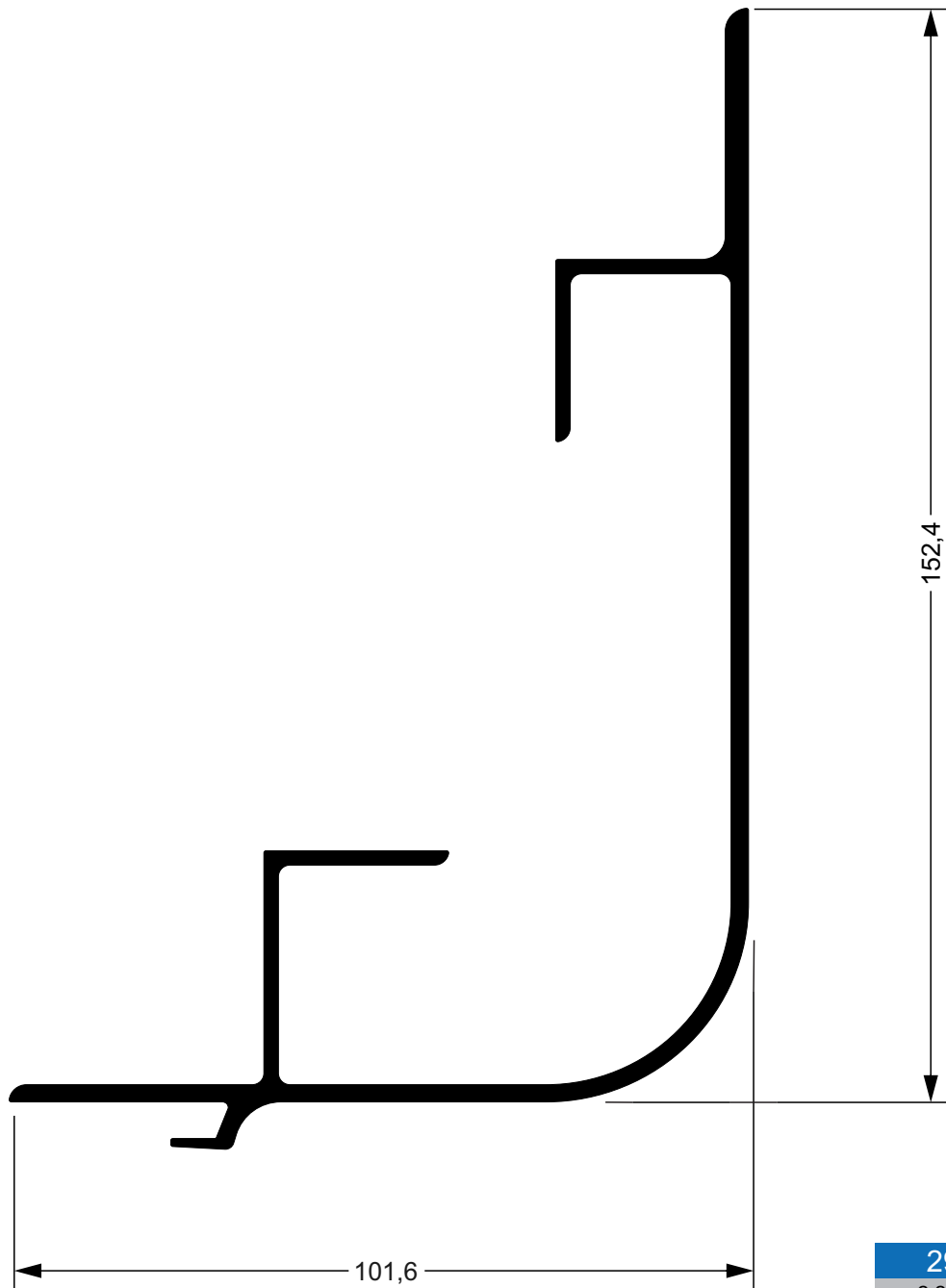

29069
2,265 kg/m
Coluna

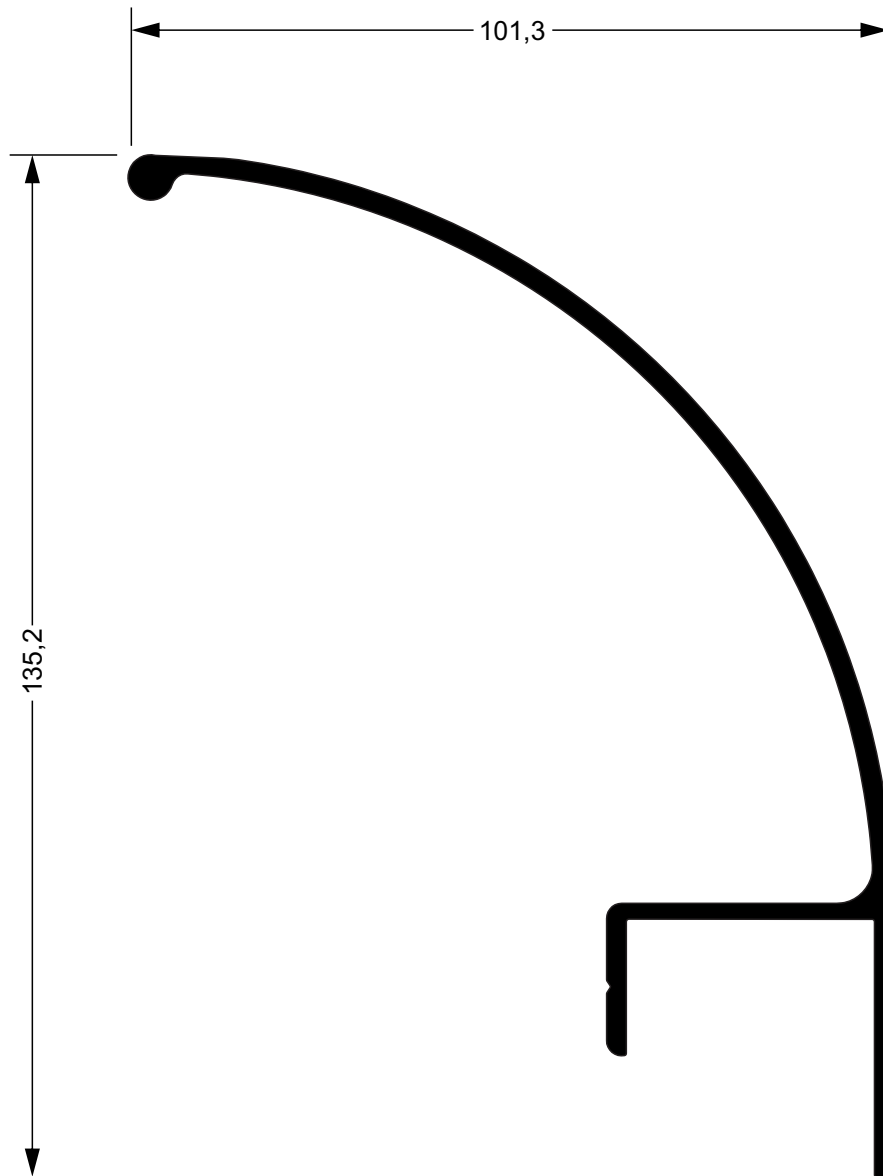

19879 C

1,720 kg/m

Acabamento Lateral
Protetor Lateral

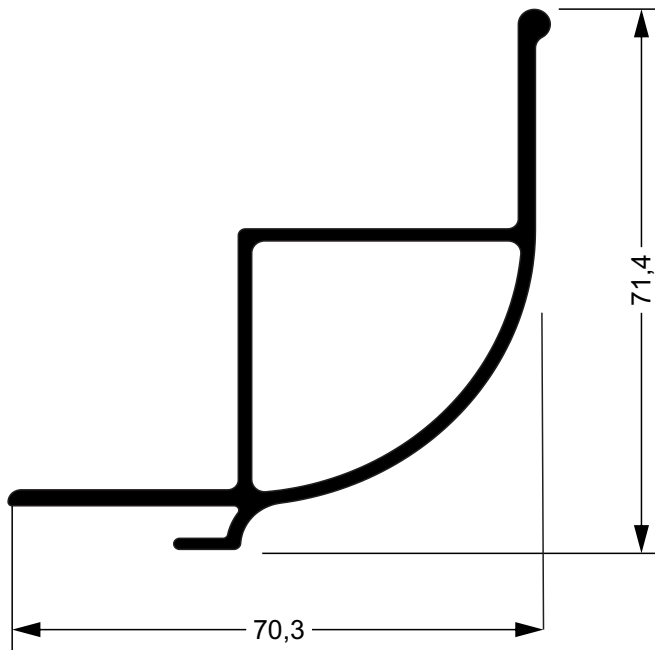

78122

1,074 kg/m

Coluna

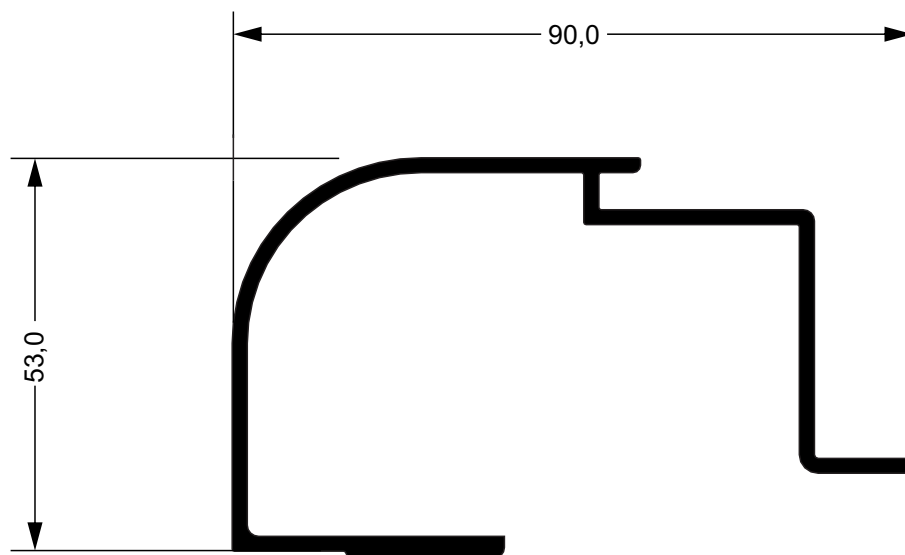

39449

1,192 kg/m

Coluna

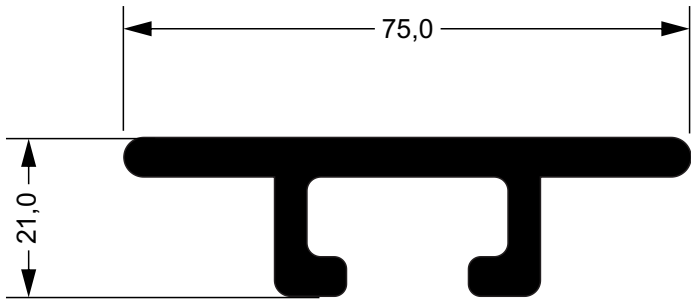

39113

1,484 kg/m

Trilho

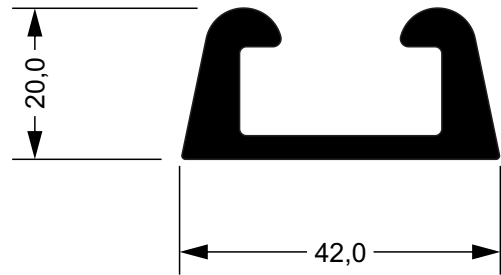

39362

0,924 kg/m

Trilho

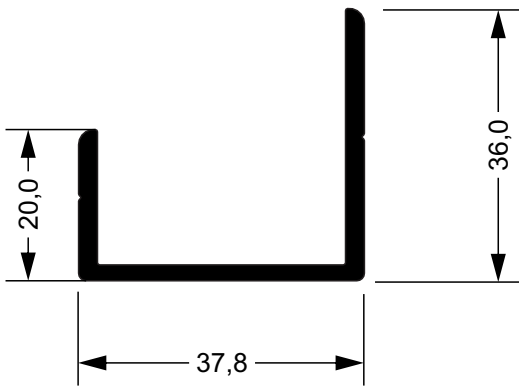

391966 C

0,559 kg/m

Acabamento Lateral

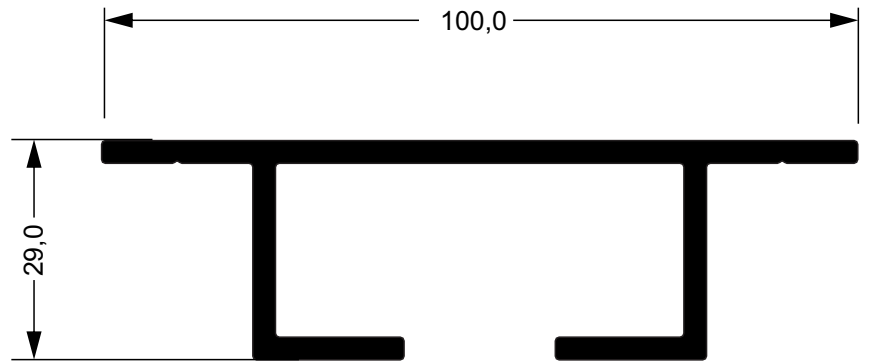

391595 C

1,510 kg/m

Trilho

39154

2,432 kg/m

Piso

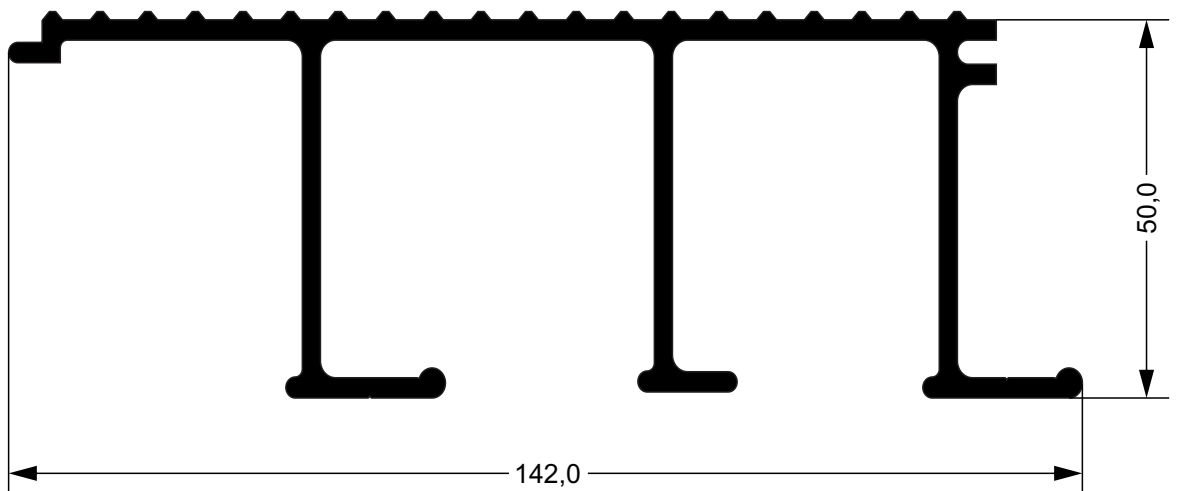

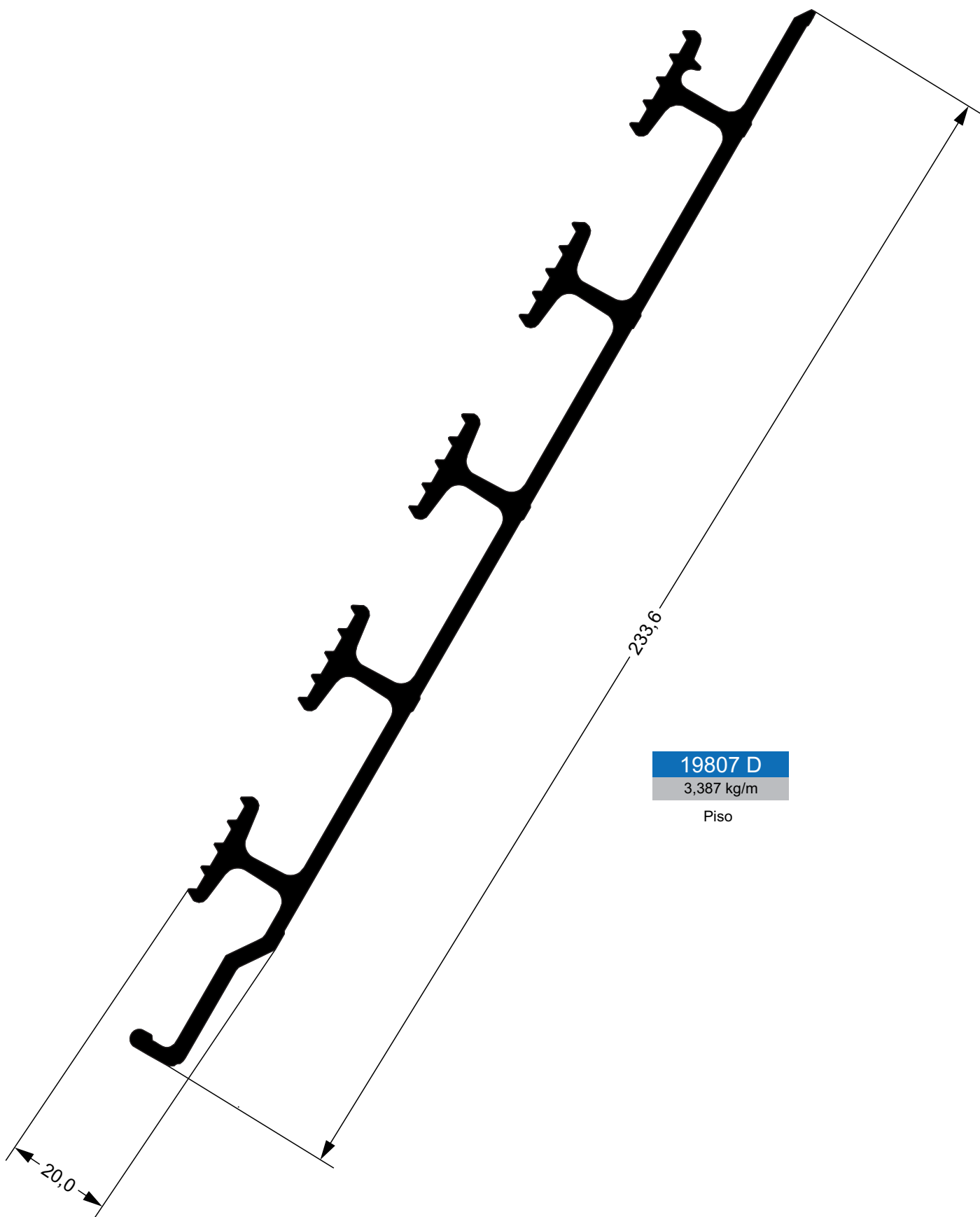

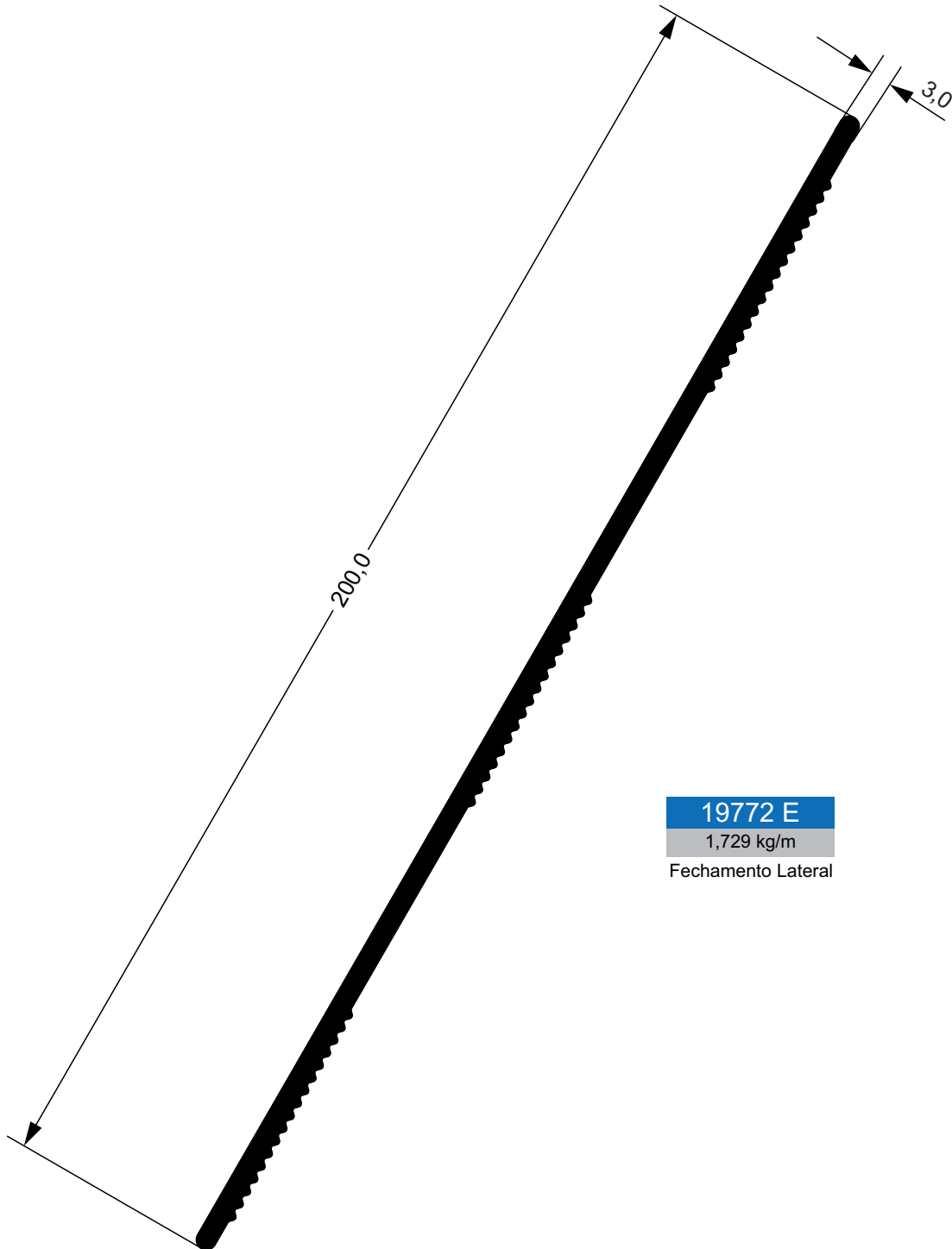

19772 E
1,729 kg/m
Fechamento Lateral

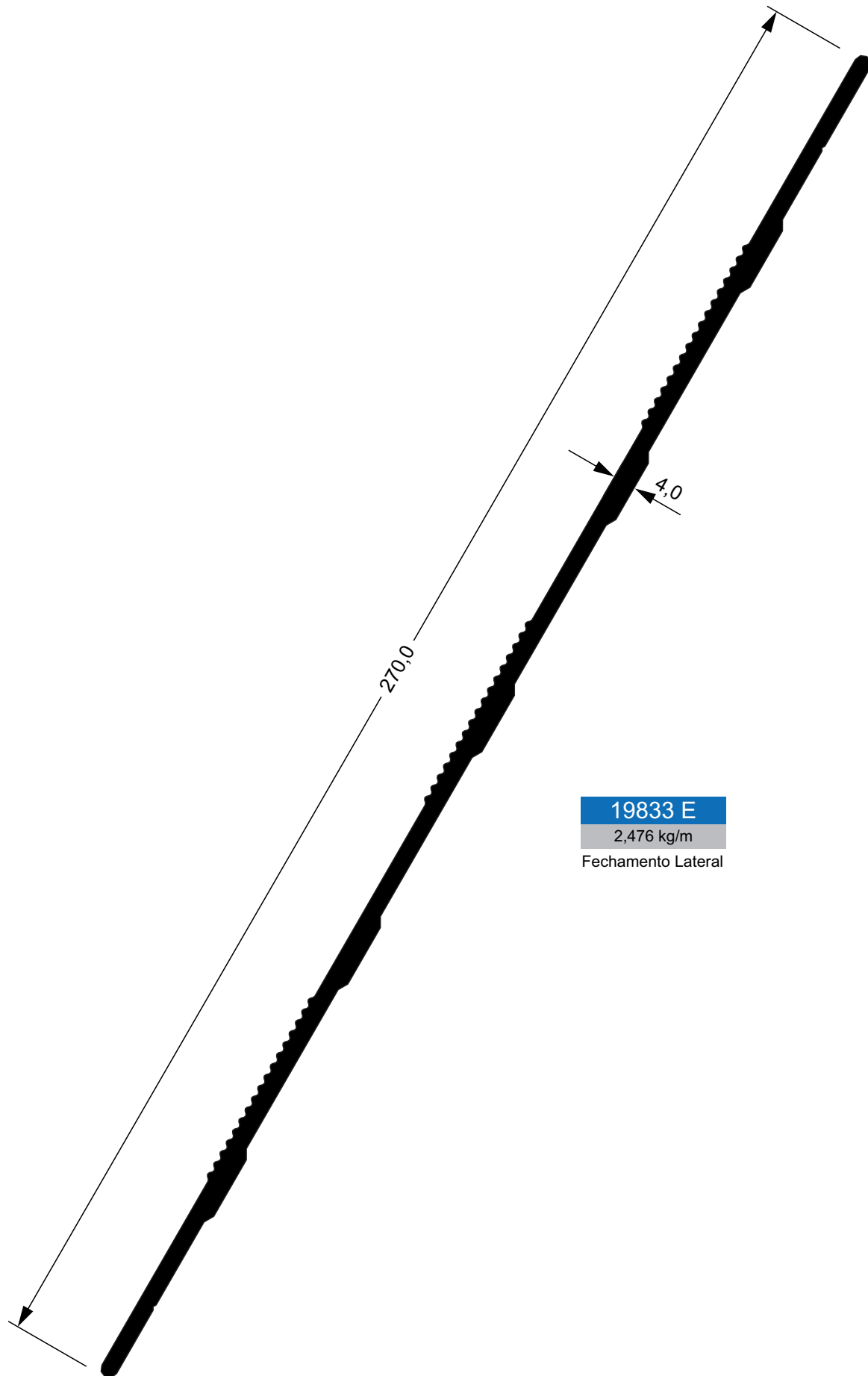

19833 E

2,476 kg/m

Fechamento Lateral

19792 E

3,930 kg/m

Assoalho

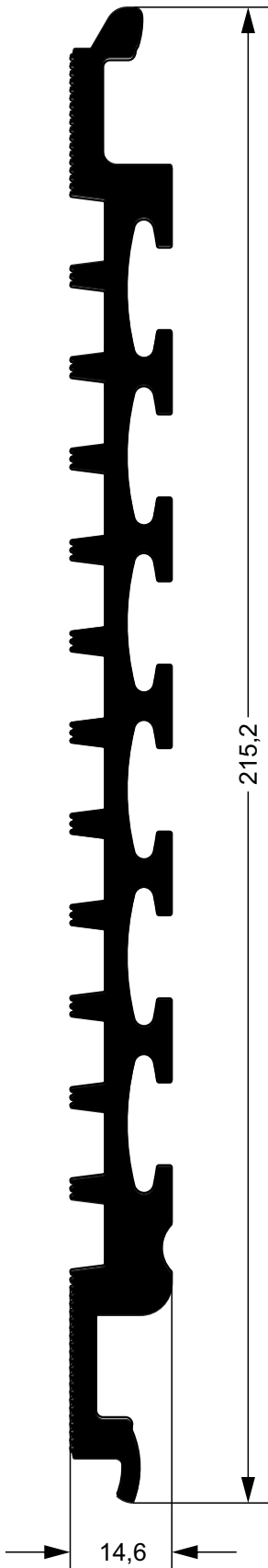

19793 E

4,016 kg/m

Assoalho

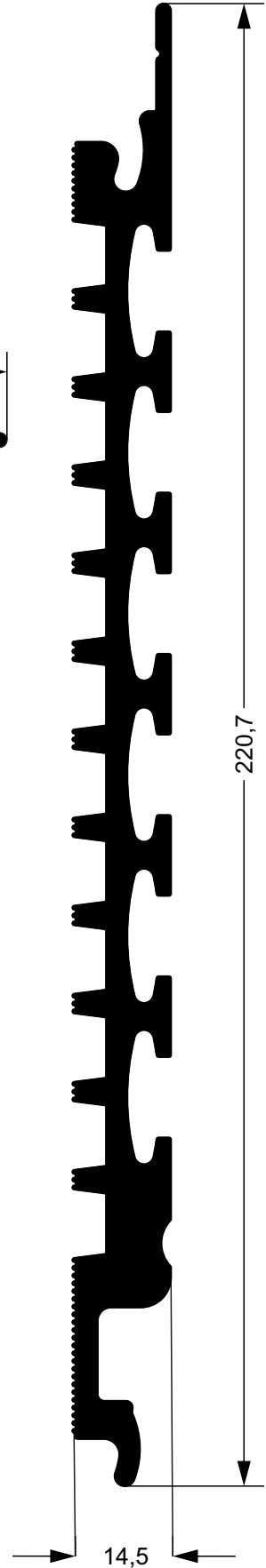

29288 E

2,189 kg/m

Lateral do Assoalho

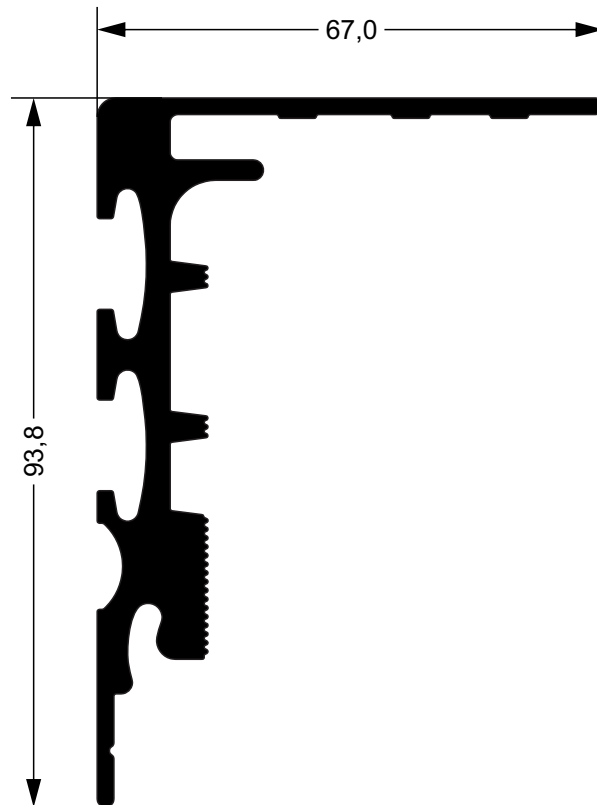

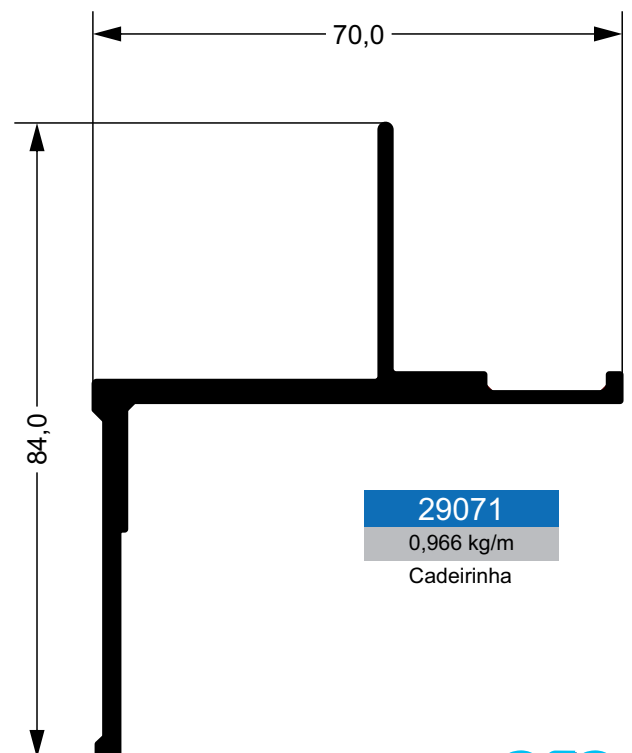
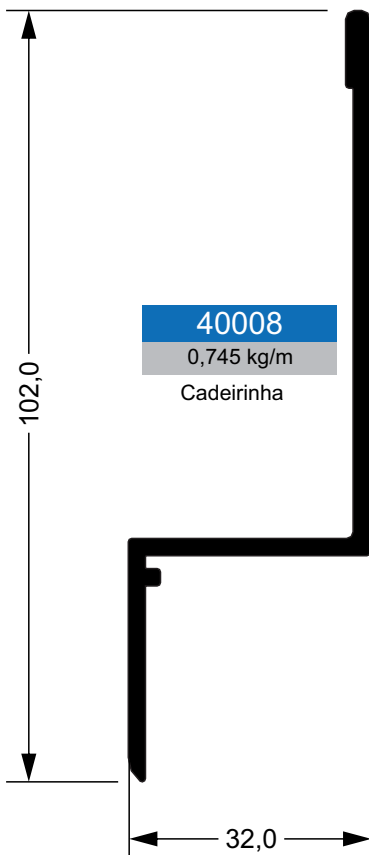
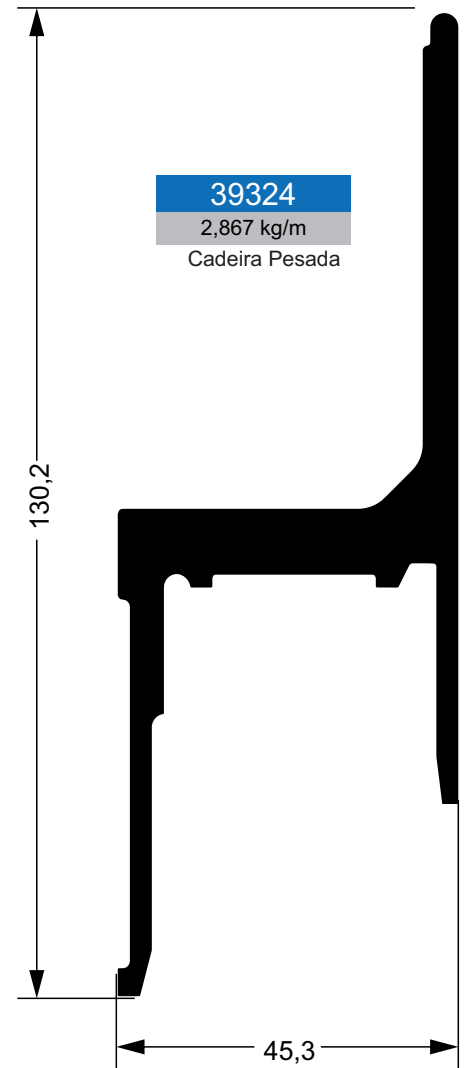
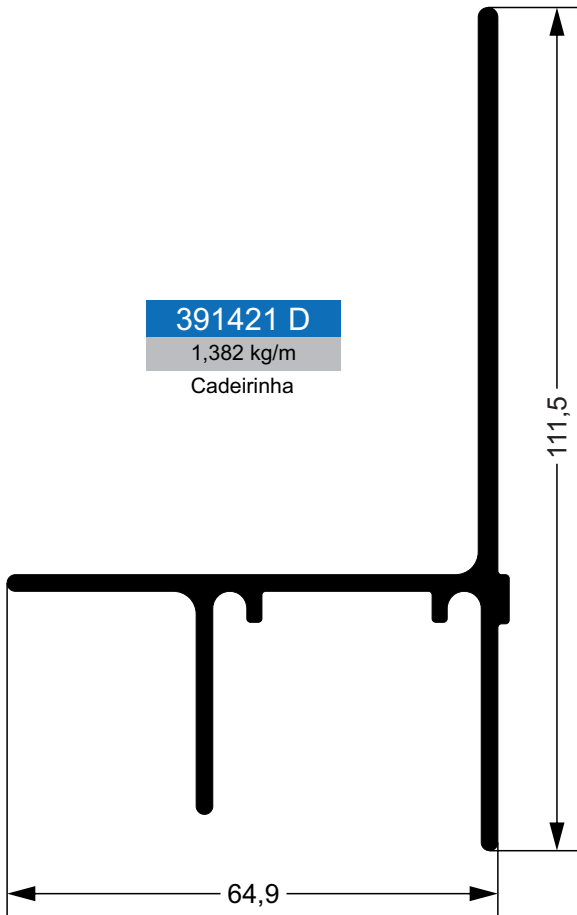

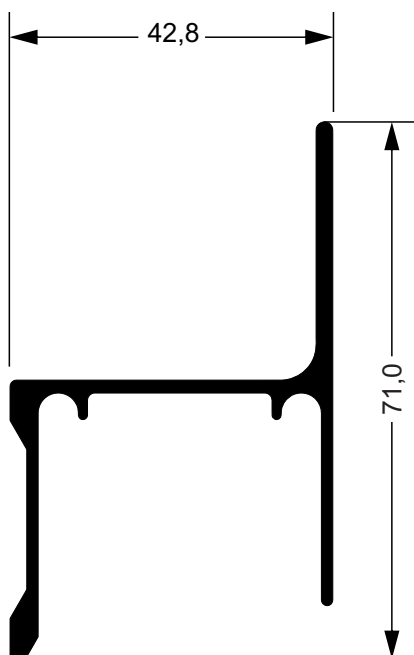

39314
0,886 kg/m
Cadeirinha

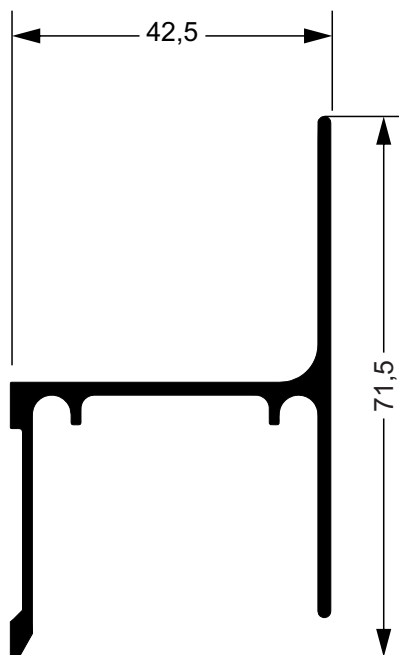

39177
0,816 kg/m
Cadeirinha

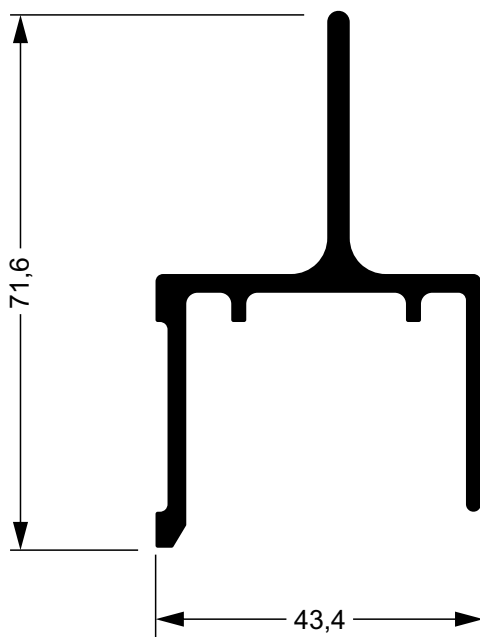

39684
1,070 kg/m
Cadeirinha

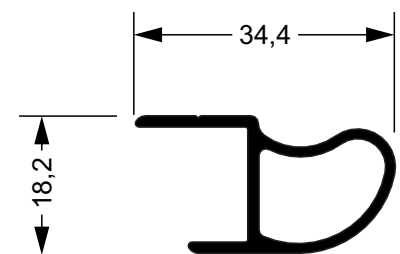
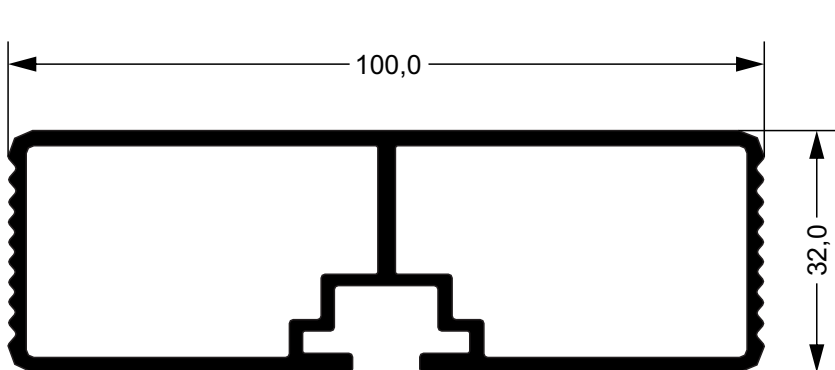
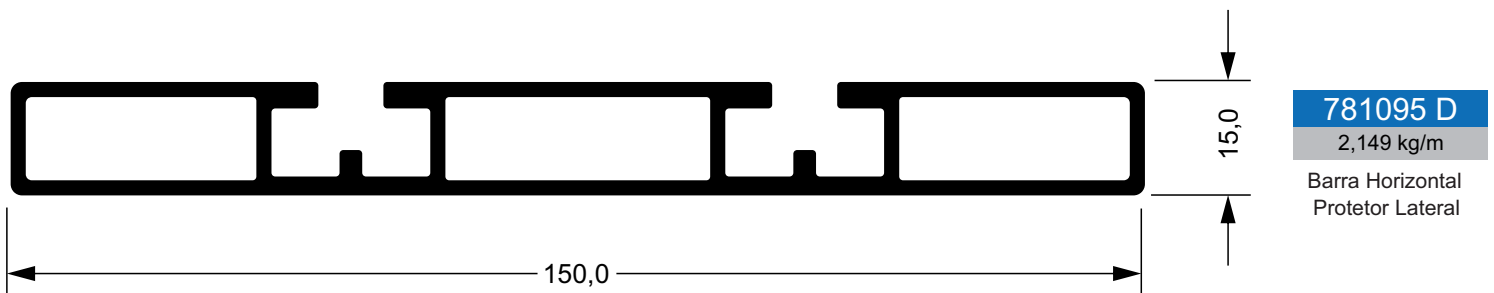
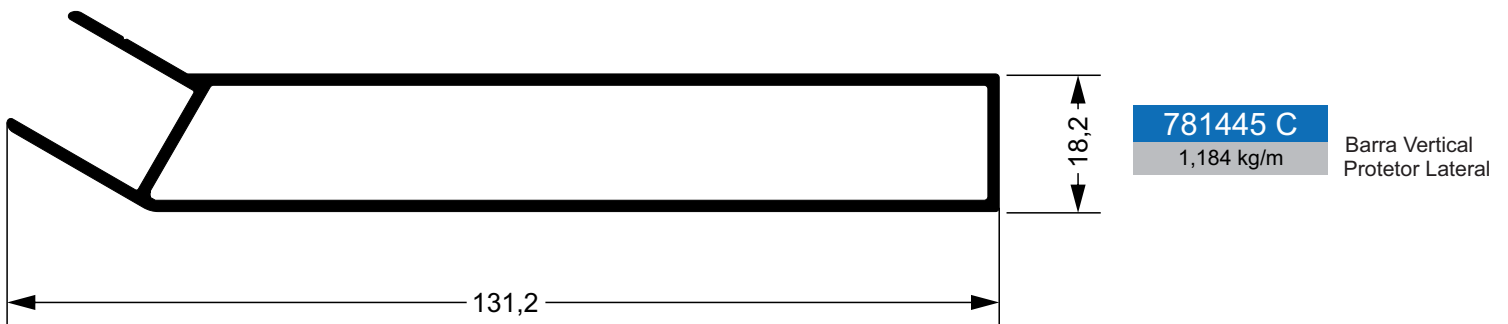
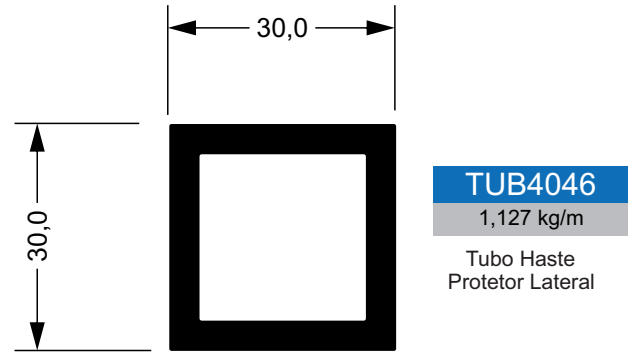
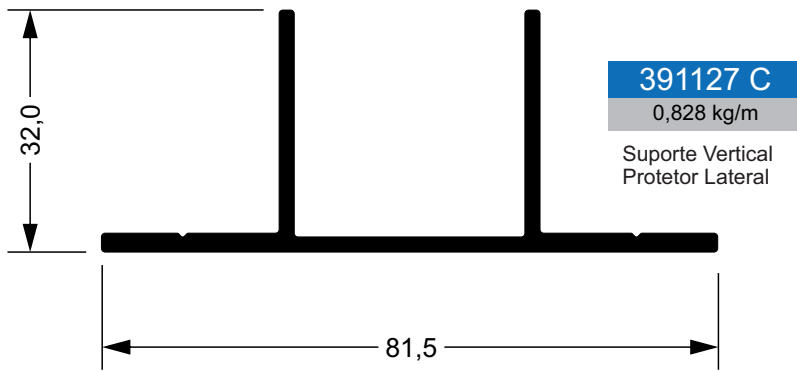

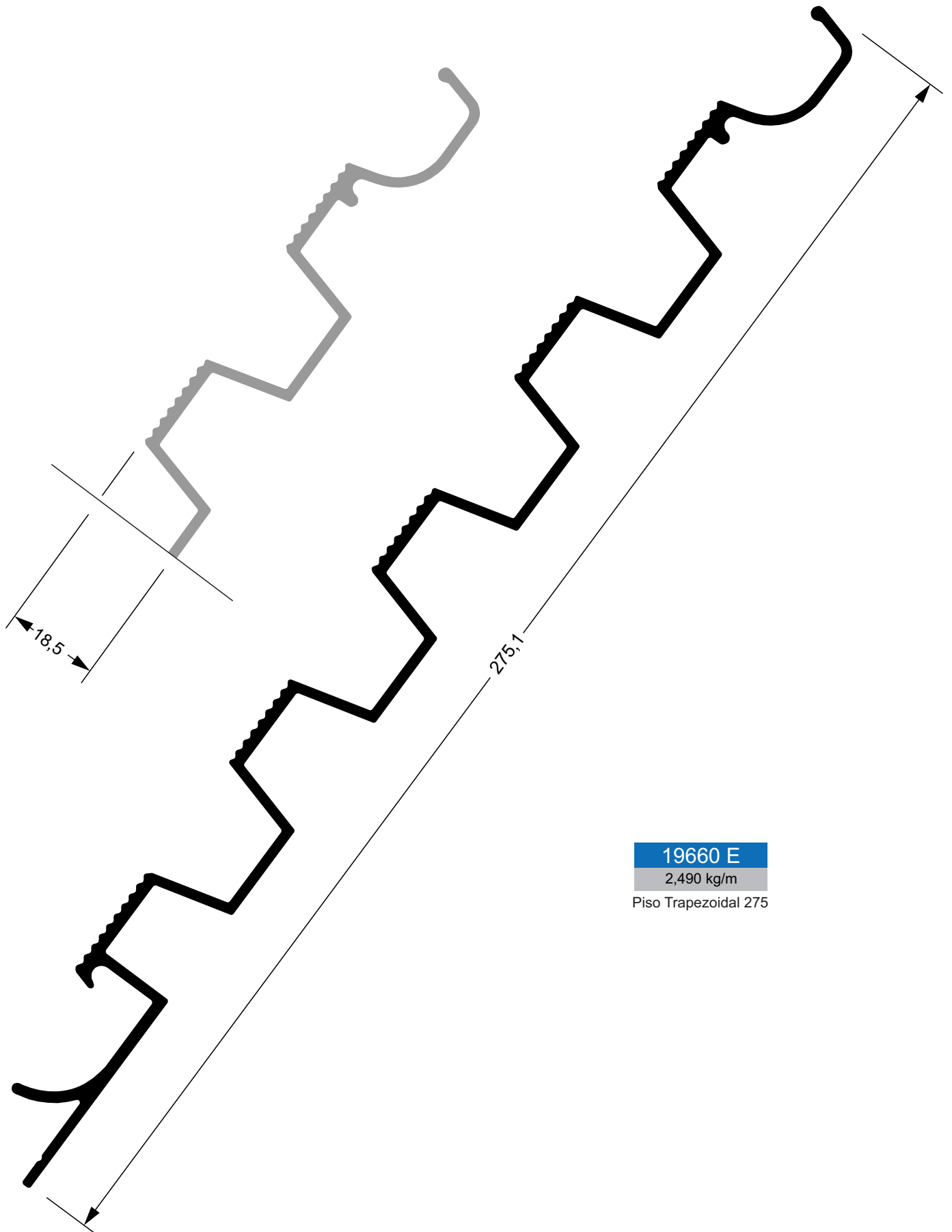

19660 E

2,490 kg/m

Piso Trapezoidal 275

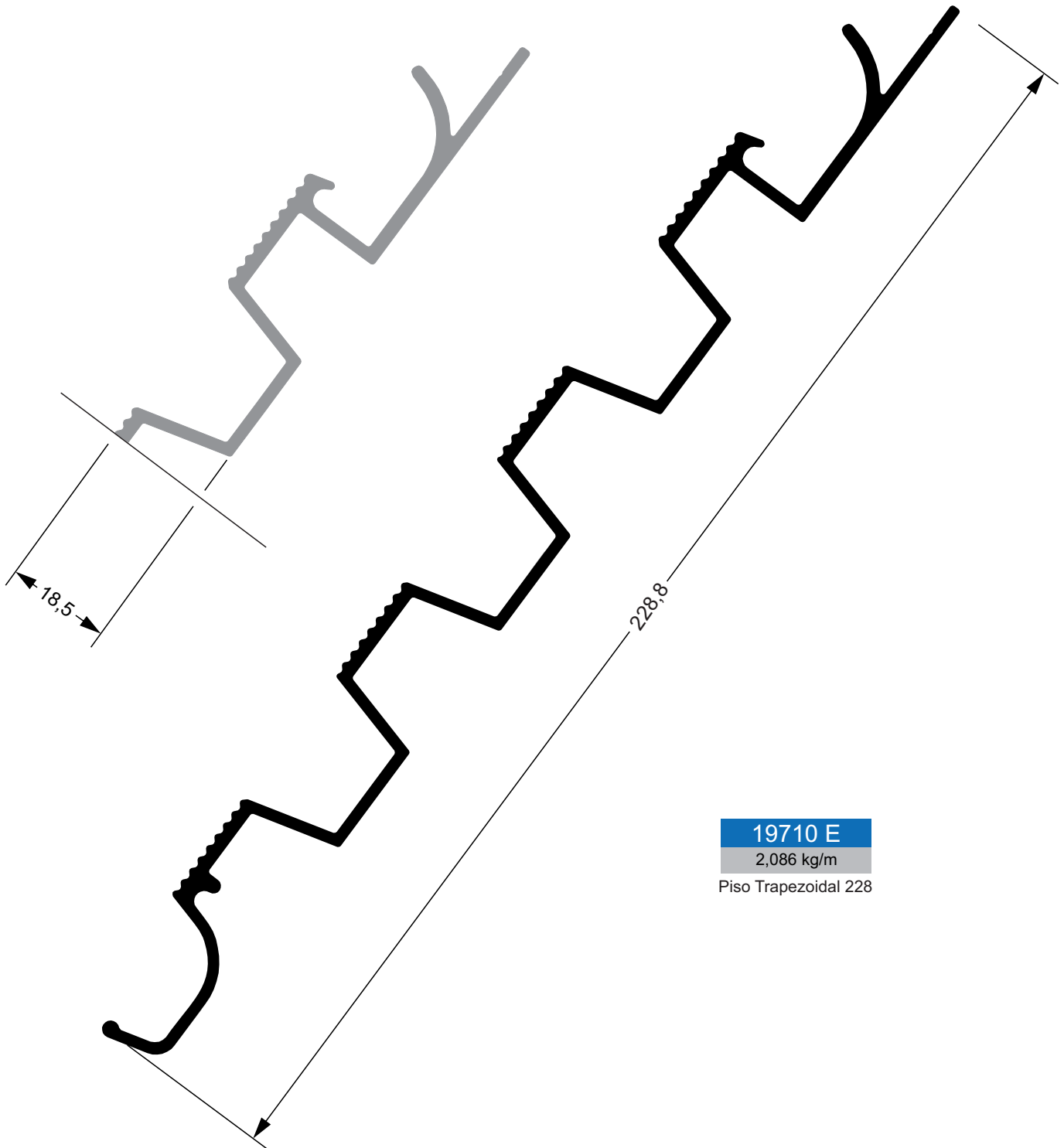

19710 E

2,086 kg/m

Piso Trapezoidal 228

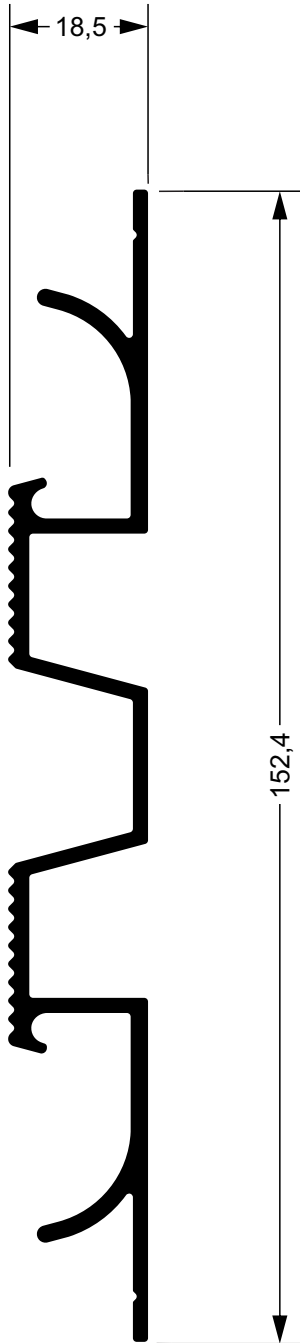

19725 C

1,496 kg/m

Piso Trapezoidal Central

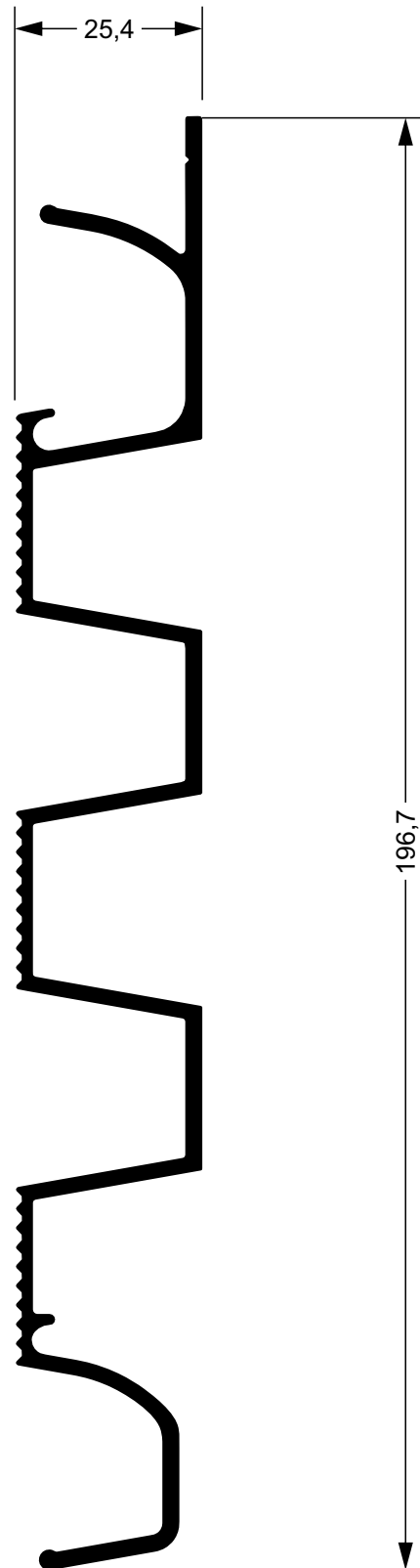

19227

2,227 kg/m

Piso Trapezoidal 196

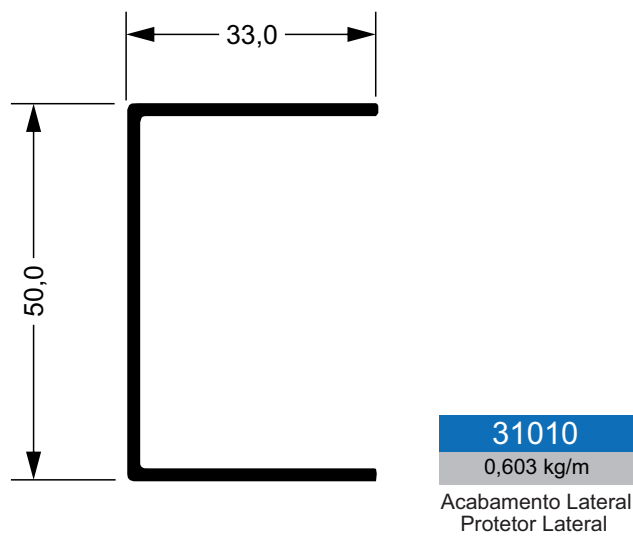
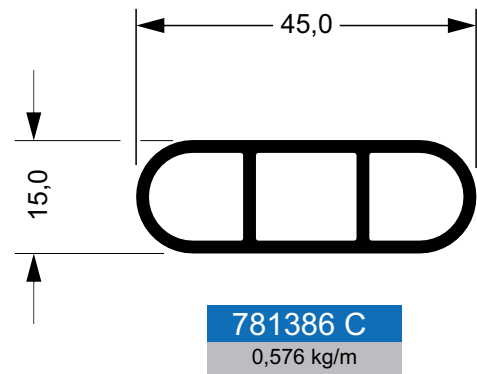
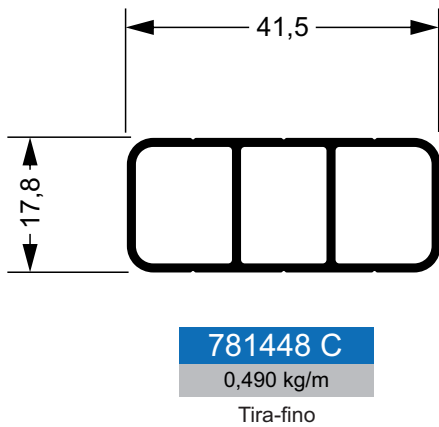
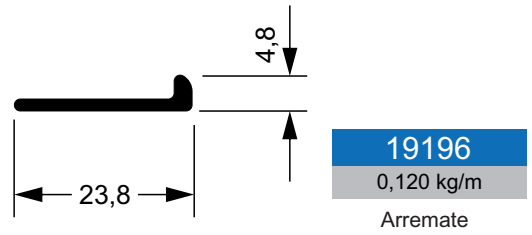
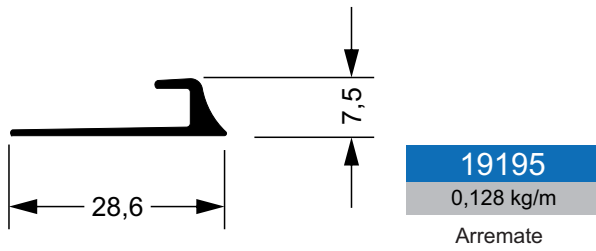

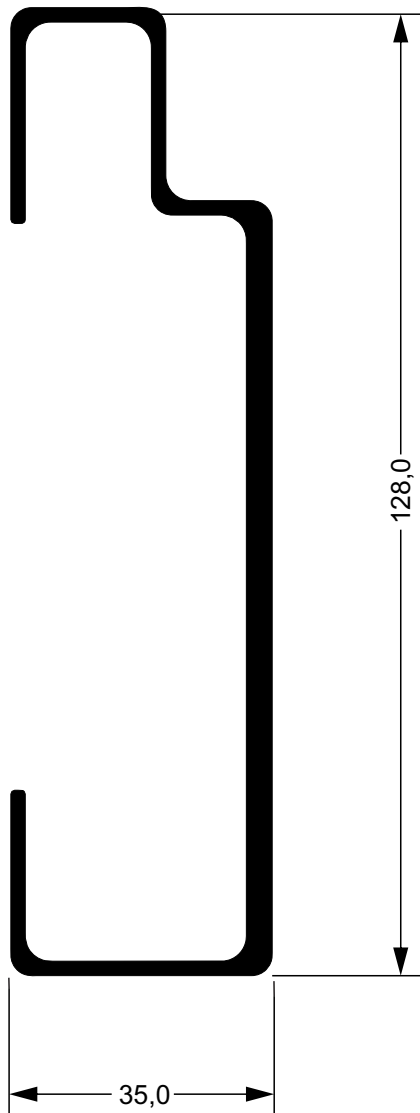

39101

2,032 kg/m

Perfil C com Vinco

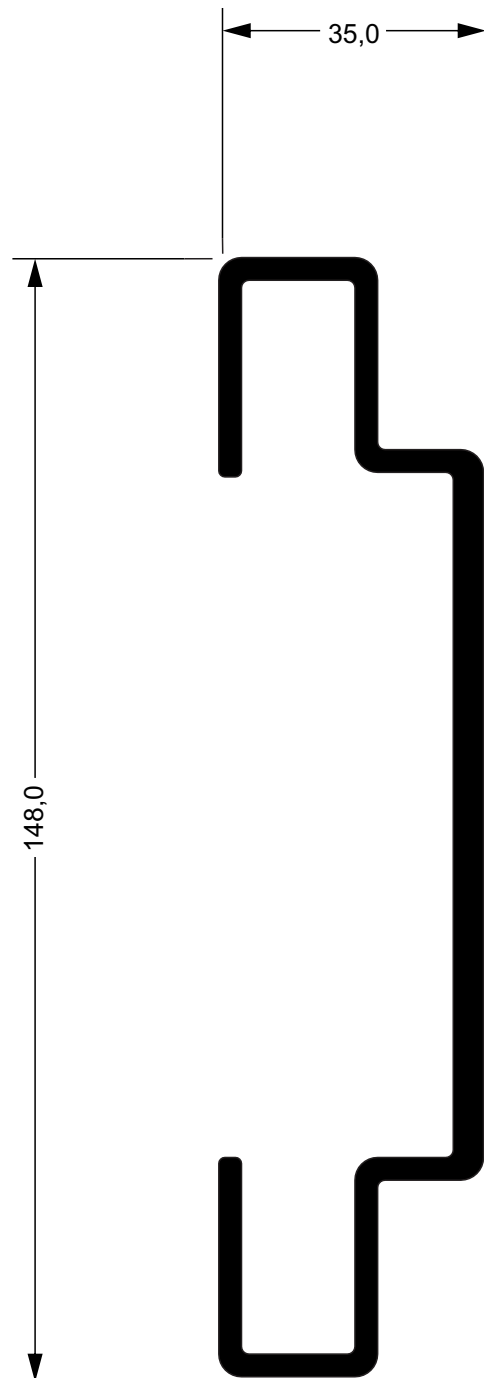

39285

2,344 kg/m

Perfil C com Vinco

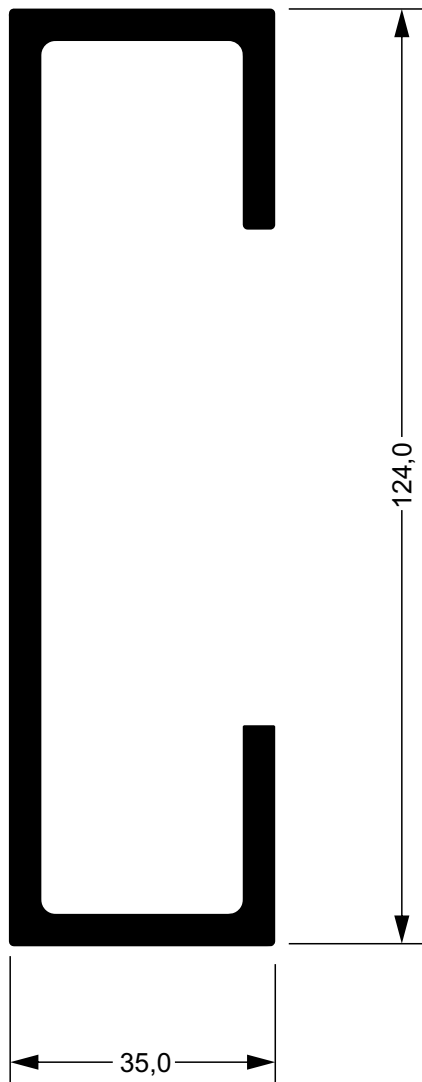

39102
2,560 kg/m
Perfil C com Vinco

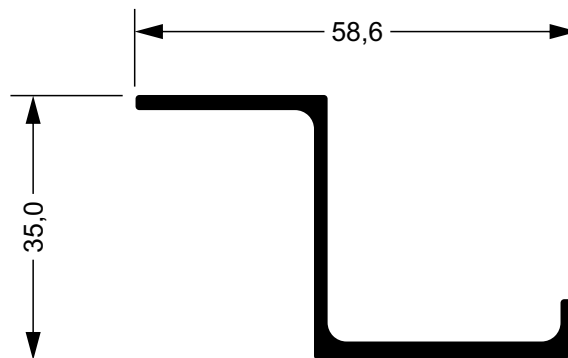

40003
0,556 kg/m
Perfil Z

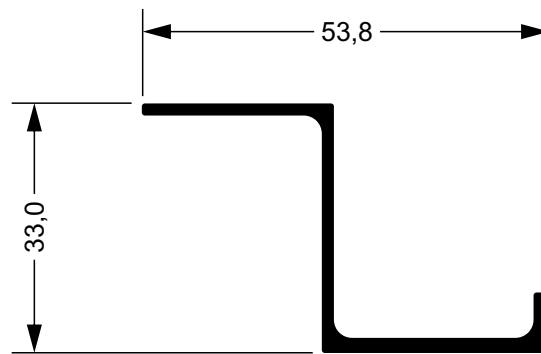

40013
0,442 kg/m
Perfil Z

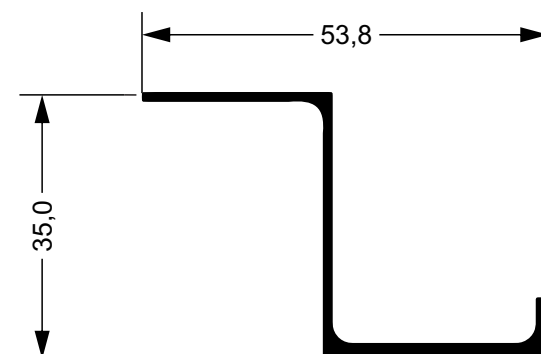

40006
0,450 kg/m
Perfil Z

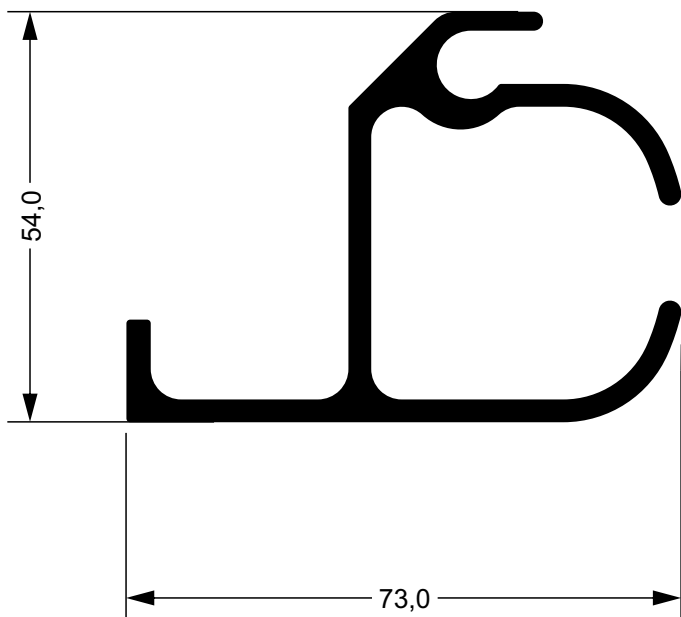

391417 C

1,848 kg/m

Perfil Trava

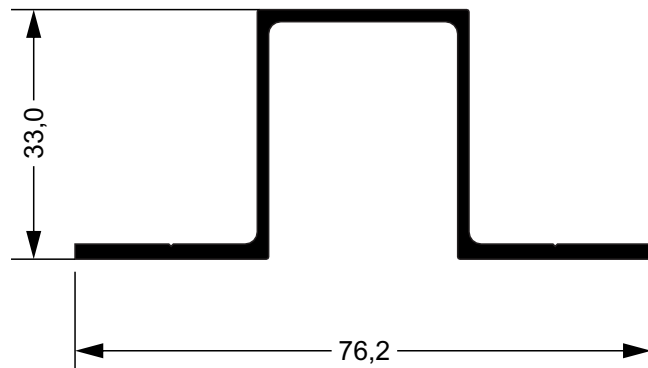

35005

0,643 kg/m

Ômega

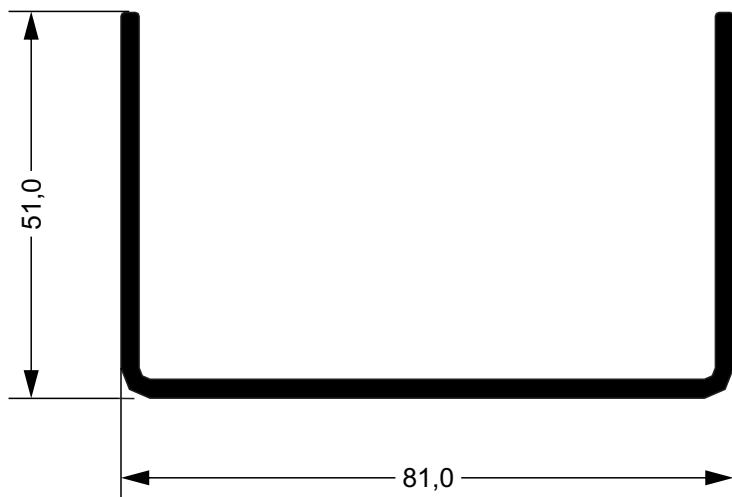

31076 C

1,189 kg/m

Acabamento Lateral
Protetor Lateral

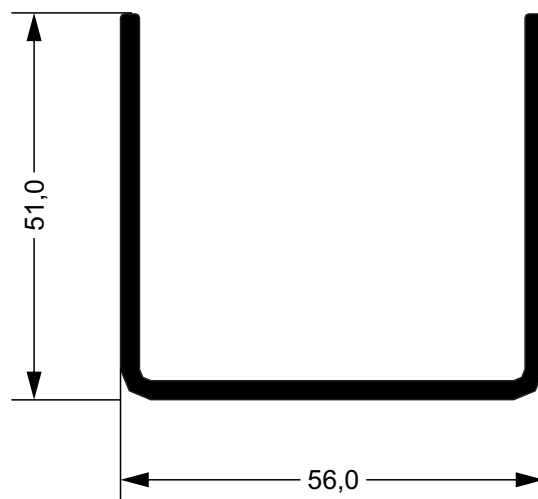

31075 C

1,019 kg/m

Acabamento Lateral
Protetor Lateral

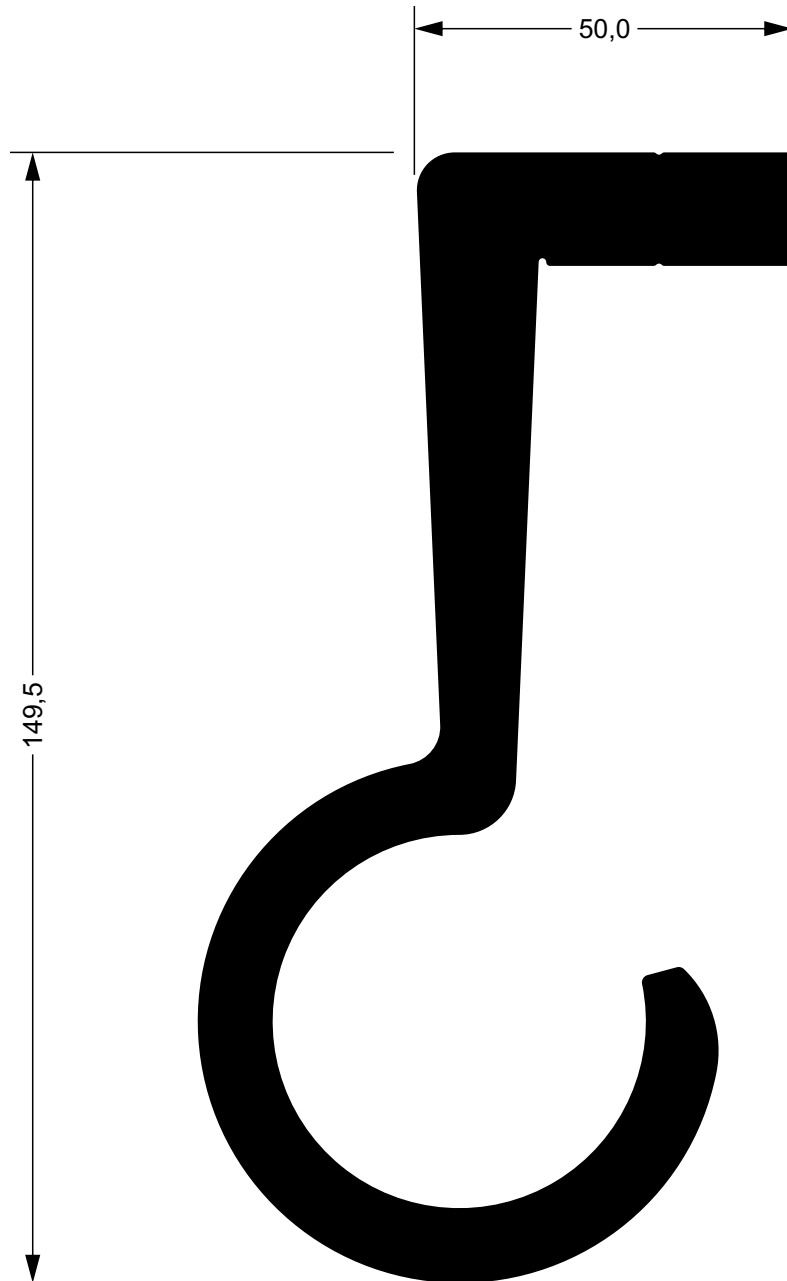

391486 D
8,372 kg/m
Gancho

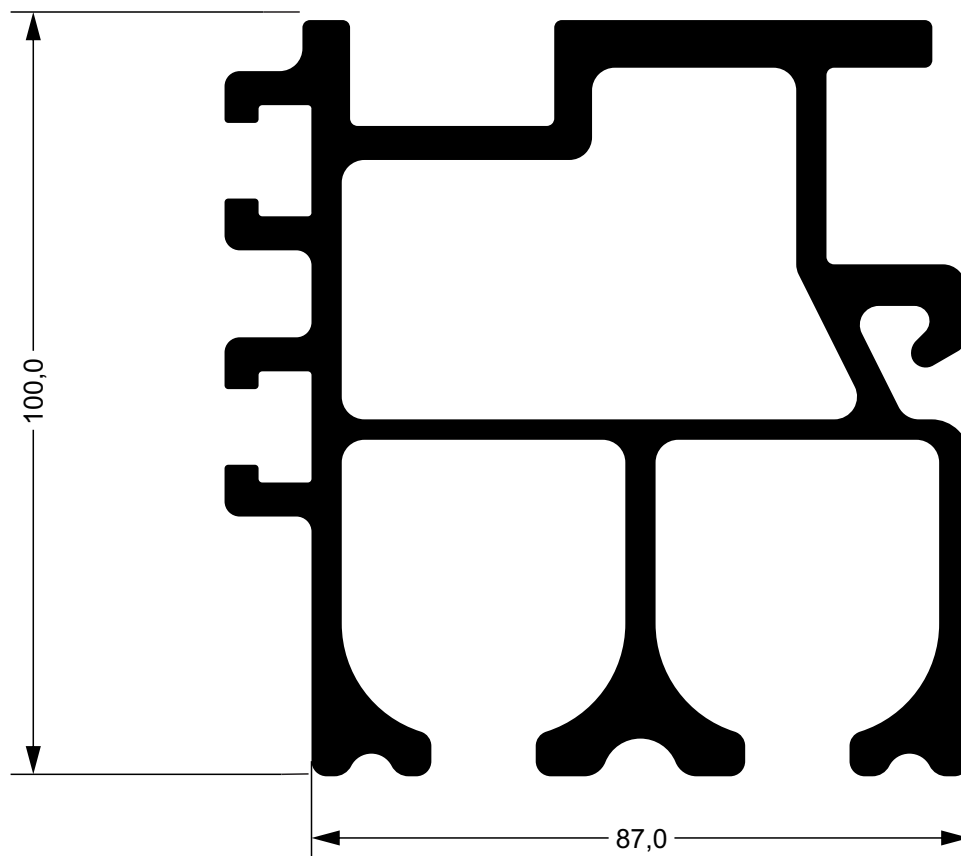

781372 E

6,672 kg/m

Trilho Sider

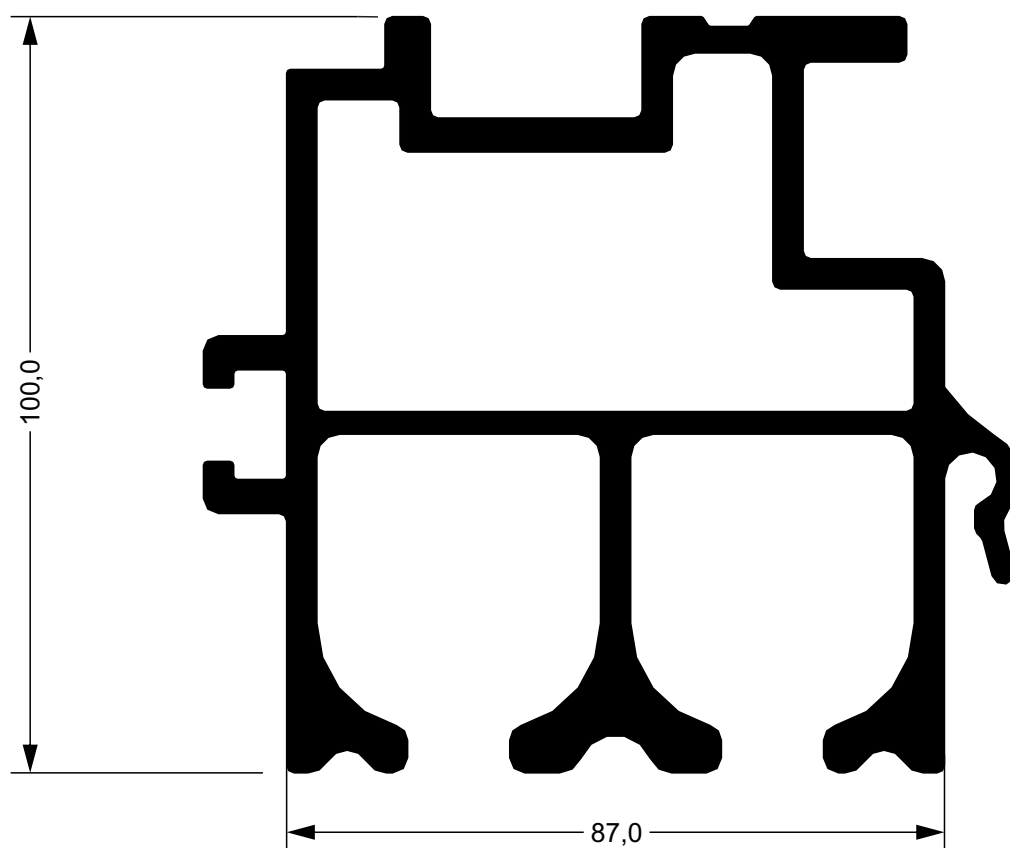

781584 E

6,287 kg/m

Perfil Sider

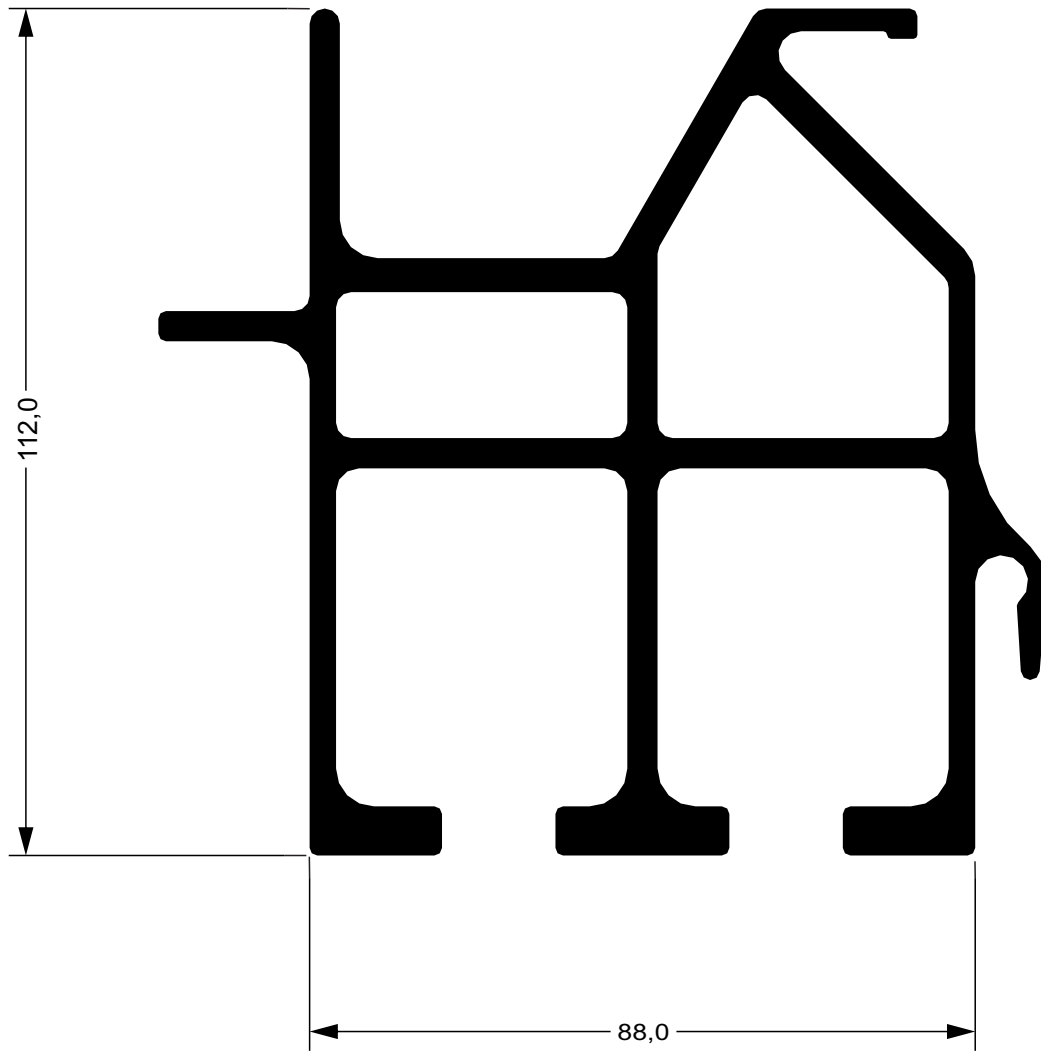

781433 E
6,497 kg/m
Perfil Sider



asa
alumínio

Baús e Carrocerias

Edição Nº 19



Implementos Rodoviários

asa
alumínio

19 3227-1000 | Rua da Cerâmica, 100 São José
19 3727-2000 | 13051-156 Campinas - SP

Nossa história, **nosso nome**, nossa identidade. **Asa sempre!**



www.asaaluminio.com.br

